

Catalan Paths and q, t -Enumeration *

J. Haglund †

Department of Mathematics
University of Pennsylvania, Philadelphia, PA 19104-6395
jhaglund@math.upenn.edu

August 12, 2014

This chapter contains an account of a two-parameter version of the Catalan numbers, and corresponding two-parameter versions of related objects such as parking functions and Schröder paths, which have become important in algebraic combinatorics and other areas of mathematics as well. Although the original motivation for the definition of these objects was the study of Macdonald polynomials and the representation theory of diagonal harmonics, in this account we focus only on the combinatorics associated to their description in terms of lattice paths. Hence this chapter can be read by anyone with a modest background in combinatorics. In Section 1 we include basic facts involving q -analogues, permutation statistics, and symmetric functions which we need in later sections. Sections 2, 3, and 4 contain the results on the q, t -versions of the Catalan numbers, parking functions, and Schröder paths, respectively. Section 5 contains a brief account of the recent exciting extensions of these objects which have arisen in the study of string theory, knot invariants, and the Hilbert scheme from algebraic geometry.

1 Introduction to q -Analogues and Catalan Numbers

Permutation Statistics and Gaussian Polynomials

In combinatorics a q -analogue of a counting function is typically a polynomial in q which reduces to the function in question when $q = 1$, and furthermore satisfies versions of some or all of the algebraic properties, such as recursions, of the function. We sometimes regard q as a real parameter satisfying $0 < q < 1$. We define the q -analogue of the real number x , denoted $[x]$ as

$$[x] = \frac{1 - q^x}{1 - q}.$$

By l'Hôpital's rule, $[x] \rightarrow x$ as $q \rightarrow 1^-$. Let \mathbb{N} denote the nonnegative integers. For $n \in \mathbb{N}$, we define the q -analogue of $n!$, denoted $[n]!$ as

$$[n]! = \prod_{i=1}^n [i] = (1 + q)(1 + q + q^2) \cdots (1 + q + \cdots + q^{n-1}).$$

*Much of this chapter is a condensed version of Chapters 1, 3, 4, and 5 of the author's book *The q, t -Catalan Numbers and the Space of Diagonal Harmonics: With an Appendix on the Combinatorics of Macdonald Polynomials*, ©2008 American Mathematical Society (AMS) and is reused here with the kind permission of the AMS.

†Work supported by NSF grant DMS-1200296

We let $|S|$ denote the cardinality of a finite set S . By a *statistic* on a set S we mean a combinatorial rule which associates an element of \mathbb{N} to each element of S . A permutation statistic is a statistic on the symmetric group S_n . We use the one-line notation $\sigma_1\sigma_2\cdots\sigma_n$ for the element $\sigma = \begin{pmatrix} 1 & 2 & \cdots & n \\ \sigma_1 & \sigma_2 & \cdots & \sigma_n \end{pmatrix}$ of S_n . More generally, a word (or multiset permutation) $\sigma_1\sigma_2\cdots\sigma_n$ is a linear list of the elements of some multiset of nonnegative integers. (The reader may wish to consult [Sta12, Chapter 1] for more background on multiset permutations.) An *inversion* of a word σ is a pair (i, j) , $1 \leq i < j \leq n$ such that $\sigma_i > \sigma_j$. A *descent* of σ is an integer i , $1 \leq i \leq n - 1$, for which $\sigma_i > \sigma_{i+1}$. The set of such i is known as the descent set, denoted $\text{Des}(\sigma)$. We define the inversion statistic $\text{inv}(\sigma)$ as the number of inversions of σ and the major index statistic $\text{maj}(\sigma)$ as the sum of the descents of σ , i.e.

$$\text{inv}(\sigma) = \sum_{\substack{i < j \\ \sigma_i > \sigma_j}} 1, \quad \text{maj}(\sigma) = \sum_{\substack{i \\ \sigma_i > \sigma_{i+1}}} i.$$

For example, $\text{inv}(613524) = 8$, while $\text{Des}(613524) = \{1, 4\}$ and $\text{maj}(613524) = 5$.

A permutation statistic is said to be *Mahonian* if its distribution over S_n is $[n]!$.

Theorem 1 *Both inv and maj are Mahonian, i.e.*

$$\sum_{\sigma \in S_n} q^{\text{inv}(\sigma)} = [n]! = \sum_{\sigma \in S_n} q^{\text{maj}(\sigma)}. \quad (1)$$

Proof. Given $\beta \in S_{n-1}$, let $\beta(k)$ denote the permutation in S_n obtained by inserting n between the $(k-1)$ st and k th elements of β . For example, $2143(3) = 21543$. Clearly $\text{inv}(\beta(k)) = \text{inv}(\beta) + n - k$, so

$$\sum_{\sigma \in S_n} q^{\text{inv}(\sigma)} = \sum_{\beta \in S_{n-1}} (1 + q + q^2 + \cdots + q^{n-1}) q^{\text{inv}(\beta)} \quad (2)$$

and thus by induction inv is Mahonian.

A modified version of this idea works for maj . Say the descents of $\beta \in S_{n-1}$ are at places $i_1 < i_2 < \cdots < i_s$. Then

$$\begin{aligned} \text{maj}(\beta(n)) &= \text{maj}(\beta), & \text{maj}(\beta(i_s + 1)) &= \text{maj}(\beta) + 1, \\ \dots, \text{maj}(\beta(i_1 + 1)) &= \text{maj}(\beta) + s, & \text{maj}(\beta(1)) &= s + 1. \end{aligned}$$

If the non-descents less than $n-1$ of β are at places $\alpha_1 < \alpha_2 < \cdots < \alpha_{n-2-s}$, then

$$\text{maj}(\beta(\alpha_1 + 1)) = \text{maj}(\beta) + s - (\alpha_1 - 1) + \alpha_1 + 1 = \text{maj}(\beta) + s + 2.$$

To see why, note that $s - (\alpha_1 - 1)$ is the number of descents of β to the right of α_1 , each of which will be shifted one place to the right by the insertion of n just after β_{α_1} . Also, we have a new descent at $\alpha_1 + 1$. By similar reasoning,

$$\begin{aligned} \text{maj}(\beta(\alpha_2)) &= \text{maj}(\beta) + s - (\alpha_2 - 2) + \alpha_2 + 1 = \text{maj}(\beta) + s + 3, \\ &\vdots \\ \text{maj}(\beta(\alpha_{n-2-s})) &= \text{maj}(\beta) + s - (\alpha_{n-2-s} - (n-2-s)) + \alpha_{n-2-s} + 1 \\ &= \text{maj}(\beta) + n - 1. \end{aligned}$$

Thus

$$\sum_{\sigma \in S_n} q^{\text{maj}(\sigma)} = \sum_{\beta \in S_{n-1}} (1 + q + \dots + q^s + q^{s+1} + \dots + q^{n-1}) q^{\text{maj}(\beta)} \quad (3)$$

and again by induction maj is Mahonian. \square

Major P. MacMahon introduced the major-index statistic and proved it is Mahonian [Mac60]. Foata [Foa68] found a map Φ which sends a permutation with a given major index to another with the same value for inv. Furthermore, if we denote the descent set of σ^{-1} by $\text{Ides}(\sigma)$, then $\text{Ides}(\phi(\sigma)) = \text{Ides}(\sigma)$. The image ϕ of the map Φ can be described as follows. If $n \leq 2$, $\phi(\sigma) = \sigma$. If $n > 2$, we add a number to ϕ one at a time; begin by setting $\phi^{(1)} = \sigma_1$, $\phi^{(2)} = \sigma_1\sigma_2$ and $\phi^{(3)} = \sigma_1\sigma_2\sigma_3$. Then if $\sigma_2 > \sigma_3$, draw a bar after each element of $\phi^{(3)}$ which is greater than σ_3 , while if $\sigma_2 < \sigma_3$, draw a bar after each element of $\phi^{(3)}$ which is less than σ_3 . Also add a bar before $\phi_1^{(3)}$. For example, if $\sigma = 4137562$ we now have $\phi^{(3)} = |41|3$. Now regard the numbers between two consecutive bars as ‘‘blocks’’, and in each block, move the last element to the beginning, and finally remove all bars. We end up with $\phi^{(3)} = 143$.

Proceeding inductively, we begin by letting $\phi^{(i)}$ be the result of adding σ_i to the end of $\phi^{(i-1)}$. Then if $\sigma_{i-1} > \sigma_i$, draw a bar after each element of $\phi^{(i)}$ which is greater than σ_i , while if $\sigma_{i-1} < \sigma_i$, draw a bar after each element of $\phi^{(i)}$ which is less than σ_i . Also draw a bar before $\phi_1^{(i)}$. Then in each block, move the last element to the beginning, and finally remove all bars. If $\sigma = 4137562$ the successive stages of the algorithm yield

$$\begin{aligned} \phi^{(3)} &= 143 \\ \phi^{(4)} &= |1|4|3|7 \rightarrow 1437 \\ \phi^{(5)} &= |1437|5 \rightarrow 71435 \\ \phi^{(6)} &= |71|4|3|5|6 \rightarrow 174356 \\ \phi^{(7)} &= |17|4|3|5|6|2 \rightarrow 7143562 \end{aligned}$$

and so $\phi(4137562) = 7143562$.

Proposition 1 *We have $\text{maj}(\sigma) = \text{inv}(\phi(\sigma))$. Furthermore, $\text{Ides}(\sigma) = \text{Ides}(\phi(\sigma))$, and also $\phi(\sigma)$ and σ have the same last letter.*

Proof. We claim $\text{inv}(\phi^{(k)}) = \text{maj}(\sigma_1 \cdots \sigma_k)$ for $1 \leq k \leq n$. Clearly this is true for $k \leq 2$. Assume it is true for $k < j$, where $2 < j \leq n$. If $\sigma_{j-1} > \sigma_j$, $\text{maj}(\sigma_1 \cdots \sigma_j) = \text{maj}(\sigma_1 \cdots \sigma_{j-1}) + j - 1$. On the other hand, for each block arising in the procedure creating $\phi^{(j)}$, the last element is greater than σ_j , which creates a new inversion, and when it is moved to the beginning of the block, it also creates a new inversion with each element in its block. It follows that $\text{inv}(\phi^{(j)}) = \text{inv}(\phi^{(j-1)}) + j - 1$. Similar remarks hold if $\sigma_{j-1} < \sigma_j$. In this case $\text{maj}(\sigma_1 \cdots \sigma_{j-1}) = \text{maj}(\sigma_1 \cdots \sigma_j)$. Also, each element of ϕ which is not the last element in its block is larger than σ_j , which creates a new inversion, but a corresponding inversion between this element and the last element in its block is lost when we cycle the last element to the beginning. Hence $\text{inv}(\phi^{(j-1)}) = \text{inv}(\phi^{(j)})$ and the claim follows.

Note that $\text{Ides}(\sigma)$ equals the set of all i , $1 \leq i < n$ such that $i + 1$ occurs before i in σ . In order for the ϕ map to change this set, at some stage, say when creating $\phi^{(j)}$, we must move i

from the end of a block to the beginning, passing $i - 1$ or $i + 1$ along the way. But this could only happen if σ_j is strictly between i and either $i - 1$ or $i + 1$, an impossibility. \square

We now show that the map Φ is invertible by constructing the permutation $\beta = \Phi^{-1}(\sigma)$. Begin by setting $\beta^{(1)} = \sigma$. Then if $\sigma_n > \sigma_1$, draw a bar *before* each number in $\beta^{(1)}$ which is less than σ_n , and also before σ_n . If $\sigma_n < \sigma_1$, draw a bar before each number in $\beta^{(1)}$ which is greater than σ_n , and also before σ_n . Next move each number at the beginning of a block to the end of the block.

The last letter of β is now fixed. Next set $\beta^{(2)} = \beta^{(1)}$, and compare the $n - 1$ st letter with the first, creating blocks as above, and draw an extra bar before the $n - 1$ st letter. For example, if $\sigma = 7143562$ the successive stages of the algorithm to construct β yield

$$\begin{aligned}\beta^{(1)} &= |71|4|3|5|6|2 \rightarrow 1743562 \\ \beta^{(2)} &= |17|4|3|5|62 \rightarrow 7143562 \\ \beta^{(3)} &= |7143|562 \rightarrow 1437562 \\ \beta^{(4)} &= |1|4|3|7562 \rightarrow 1437562 \\ \beta^{(5)} &= |14|37562 \rightarrow 4137562 \\ \beta^{(6)} &= \beta^{(7)} = 4137562\end{aligned}$$

and so $\Phi^{-1}(7143562) = 4137562$. Notice that at each stage we are reversing the steps of the algorithm to compute ϕ , and it is easy to see this holds in general.

An *involution* on a set S is a bijective map from S to S whose square is the identity. Foata and Schützenberger [FS78] showed that the map $i\Phi i\Phi^{-1}i$, where i is the inverse map on permutations, is an involution on S_n which interchanges *inv* and *maj*.

For $n, k \in \mathbb{N}$ with $0 \leq k \leq n$, let

$$\begin{bmatrix} n \\ k \end{bmatrix} = \begin{bmatrix} n \\ k \end{bmatrix}_q = \frac{[n]!}{[k]![n-k]!} = \frac{(1-q^n)(1-q^{n-1})\cdots(1-q^{n-k+1})}{(1-q^k)(1-q^{k-1})\cdots(1-q)} \quad (4)$$

denote the Gaussian polynomial. These are special cases of more general objects known as q -binomial coefficients, which are defined for $x \in \mathbb{R}$ as

$$\begin{bmatrix} x \\ k \end{bmatrix} = \frac{(q^{x-k+1}; q)_k}{(q; q)_k}, \quad (5)$$

where $(a; q)_k = (a)_k = (1-a)(1-qa)\cdots(1-q^{k-1}a)$ is the “ q -rising factorial”.

A partition λ is a nonincreasing finite sequence $\lambda_1 \geq \lambda_2 \geq \dots$ of positive integers. λ_i is called the i th part of λ . We let $\ell(\lambda)$ denote the number of parts, and $|\lambda| = \sum_i \lambda_i$ the sum of the parts. For various formulas it will be convenient to assume $\lambda_j = 0$ for $j > \ell(\lambda)$. The *Ferrers graph* of λ is an array of unit squares, called cells, with λ_i cells in the i th row, where the first cell in each row is left-justified. We often use λ to refer to its Ferrers graph. We define the conjugate partition, λ' as the partition whose Ferrers graph is obtained from λ by reflecting across the diagonal $x = y$, as in Figure 1. Here $(i, j) \in \lambda$ refers to a cell with (column, row) coordinates (i, j) , with the lower left-hand-cell of λ having coordinates $(1, 1)$. The notation $x \in \lambda$ means x is a cell in λ . For technical reasons we say that 0 has one partition, the empty set \emptyset , with $\ell(\emptyset) = 0 = |\emptyset|$.

The following result shows the Gaussian polynomials are in fact polynomials in q , which is not obvious from their definition.

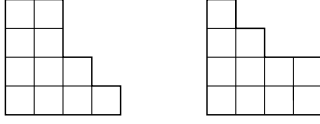

Figure 1: On the left, the Ferrers graph of the partition $(4, 3, 2, 2)$, and on the right, that of its conjugate $(4, 3, 2, 2)' = (4, 4, 2, 1)$.

Theorem 2 For $n, k \in \mathbb{N}$,

$$\begin{bmatrix} n+k \\ k \end{bmatrix} = \sum_{\lambda \subseteq n^k} q^{|\lambda|}, \quad (6)$$

where the sum is over all partitions λ whose Ferrers graph fits inside a $k \times n$ rectangle, i.e., for which $\lambda_1 \leq n$ and $\ell(\lambda) \leq k$.

Proof. Let

$$P(n, k) = \sum_{\lambda \subseteq n^k} q^{|\lambda|}.$$

Clearly

$$P(n, k) = \sum_{\substack{\lambda \subseteq n^k \\ \lambda_1 = n}} q^{|\lambda|} + \sum_{\substack{\lambda \subseteq n^k \\ \lambda_1 \leq n-1}} q^{|\lambda|} = q^n P(n, k-1) + P(n-1, k). \quad (7)$$

On the other hand

$$\begin{aligned} q^n \begin{bmatrix} n+k-1 \\ k-1 \end{bmatrix} + \begin{bmatrix} n-1+k \\ k \end{bmatrix} &= q^n \frac{[n+k-1]!}{[k-1]![n]!} + \frac{[n-1+k]!}{[k]![n-1]!} \\ &= \frac{q^n [k][n+k-1]! + [n-1+k]![n]}{[k]![n]!} \\ &= \frac{[n+k-1]!}{[k]![n]!} (q^n(1+q+\dots+q^{k-1}) + 1+q+\dots+q^{n-1}) \\ &= \frac{[n+k]!}{[k]![n]!}. \end{aligned}$$

Since $P(n, 0) = P(0, k) = 1$, both sides of (6) thus satisfy the same recurrence and initial conditions. \square

Given $\alpha = (\alpha_0, \dots, \alpha_s) \in \mathbb{N}^{s+1}$, let

$$\{0^{\alpha_0} 1^{\alpha_1} \dots s^{\alpha_s}\}$$

denote the multiset with α_i copies of i , where $\alpha_0 + \dots + \alpha_s = n$. We let M_α denote the set of all permutations of this multiset and refer to α as the *weight* of any given one of these words. Also let

$$\begin{bmatrix} n \\ \alpha_0, \dots, \alpha_s \end{bmatrix} = \frac{[n]!}{[\alpha_0]! \dots [\alpha_s]!} \quad (8)$$

denote the q -multinomial coefficient.

The following result is due to MacMahon [Mac60].

Theorem 3 Both inv and maj are multiset Mahonian, i.e. given $\alpha \in \mathbb{N}^{s+1}$,

$$\sum_{\sigma \in M_\alpha} q^{inv(\sigma)} = \left[\begin{matrix} n \\ \alpha_0, \dots, \alpha_s \end{matrix} \right] = \sum_{\sigma \in M_\alpha} q^{maj(\sigma)}. \quad (9)$$

Remark 1 Foata's map also proves Theorem 3 bijectively. To see why, given a multiset permutation σ of $M(\beta)$ let σ' denote the standardization of σ , defined to be the permutation obtained by replacing the β_0 0's by the numbers 1 through β_0 , in increasing order as we move left to right in σ , then replacing the β_1 1's by the numbers $\beta_0 + 1$ through $\beta_0 + \beta_1$, again in increasing order as we move left to right in σ , etc. For example, the standardization of 31344221 is 51678342. Note that

$$Ides(\sigma') \subseteq \{\beta_1, \beta_1 + \beta_2, \dots\} \quad (10)$$

and in fact standardization gives a bijection between elements of $M(\beta)$ and permutations satisfying (10). Since the map Φ fixes the inverse descent set, Φ maps $M(\beta)$ to itself bijectively, sending maj to inv .

Exercise 1 If σ is a word of length n define the co-major index of σ as follows.

$$comaj(\sigma) = \sum_{\substack{\sigma_i > \sigma_{i+1} \\ 1 \leq i < n}} n - i. \quad (11)$$

Show that Foata's map ϕ implies there is a bijective map $co\phi$ on words of fixed weight such that

$$comaj(\sigma) = inv(co\phi(\sigma)). \quad (12)$$

The Catalan Numbers and Dyck Paths

A lattice path is a sequence of North $N(0, 1)$ and East $E(1, 0)$ steps in the first quadrant of the xy -plane, starting at the origin $(0, 0)$ and ending at say (m, n) . We let $L_{m,n}$ denote the set of all such paths, and $L_{m,n}^+$ the subset of $L_{m,n}$ consisting of paths which never go below the line $y = \frac{n}{m}x$. A Dyck, sometimes called a Catalan path, is an element of $L_{n,n}^+$ for some n .

Let $C_n = \frac{1}{n+1} \binom{2n}{n}$ denote the n th Catalan number, so

$$C_0, C_1, \dots = 1, 1, 2, 5, 14, 42, \dots$$

There are now over 200 known combinatorial interpretations for the Catalan numbers. (See [Sta99, Ex. 6.19, p. 219] for a list of 66 of these interpretations.) One of these is the number of elements of $L_{n,n}^+$. For $1 \leq k \leq n$, the number of Dyck paths from $(0, 0)$ to (k, k) which touch the line $y = x$ only at $(0, 0)$ and (k, k) is C_{k-1} , since such a path must begin with a N step, end with an E step, and never go below the line $y = x + 1$ as it goes from $(0, 1)$ to $(k-1, k)$. The number of ways to extend such a path to (n, n) and still remain a Dyck path is clearly C_{n-k} . It follows that

$$C_n = \sum_{k=1}^n C_{k-1} C_{n-k}, \quad n \geq 1. \quad (13)$$

There are two natural q -analogues of C_n . Given $\pi \in L_{n,m}$, let $\sigma(\pi)$ be the element of $M_{(m,n)}$ resulting from the following algorithm. First initialize σ to the empty string. Next start at $(0,0)$, move along π and add a 0 to the end of $\sigma(\pi)$ every time a N step is encountered, and add a 1 to the end of $\sigma(\pi)$ every time an E step is encountered. Similarly, given $\sigma \in M_{(m,n)}$, let $\pi(\sigma)$ be the element of $L_{n,m}$ obtained by inverting the above algorithm. We call the transformation of π to σ or its inverse the *coding* of π or σ . For $\pi \in L_{n,n}^+$, let $a_i(\pi)$ denote the number of complete squares, in the i th row from the bottom of π , which are to the right of π and to the left of the line $y = x$. We refer to $a_i(\pi)$ as the *length* of the i th row of π . Furthermore call $(a_1(\pi), a_2(\pi), \dots, a_n(\pi))$ the *area vector* of π , and set $\text{area}(\pi) = \sum_i a_i(\pi)$. For example, the path in Figure 2 has area vector $(0, 1, 1, 2, 1, 2, 0)$, and $\sigma(\pi) = 00100110011101$. By convention we say $L_{0,0}^+$ contains one path, the empty path \emptyset , with $\text{area}(\emptyset) = 0$.

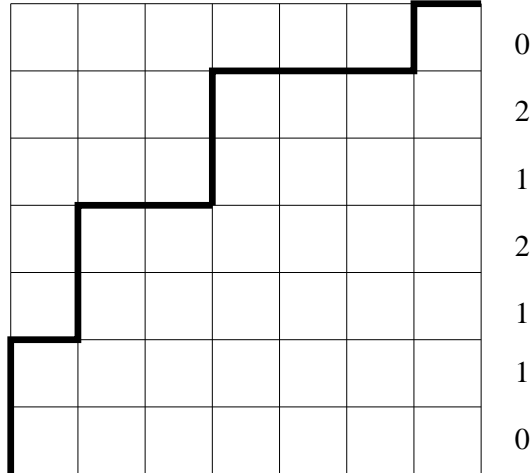

Figure 2: A Dyck path, with row lengths on the right. The area statistic is $1 + 1 + 2 + 1 + 2 = 7$.

Let $M_{(m,n)}^+$ denote the elements σ of $M_{(m,n)}$ corresponding to paths in $L_{n,m}^+$. Words in $M_{n,n}^+$ are thus characterized by the property that in any initial segment there are at least as many 0's as 1's. The first q -analogue of C_n is given by the following.

Theorem 4 (*MacMahon [Mac60, p. 214]*)

$$\sum_{\pi \in L_{n,n}^+} q^{\text{maj}(\sigma(\pi))} = \frac{1}{[n+1]} \begin{bmatrix} 2n \\ n \end{bmatrix}. \quad (14)$$

Proof. We give a *bijective* proof, taken from [FH85]. Let $M_{(m,n)}^- = M_{(m,n)} \setminus M_{(m,n)}^+$, and let $L_{n,m}^- = L_{n,m} \setminus L_{n,m}^+$ be the corresponding set of lattice paths. Given a path $\pi \in L_{n,n}^-$, let P be the point with smallest x -coordinate among those lattice points (i, j) in π for which $j - i$ is maximal, i.e. whose distance from the line $y = x$ in a SE direction is maximal. (Since $\pi \in L_{n,n}^-$, this maximal value of $i - j$ is positive.) Let P' be the lattice point on π before P . There must be an east step connecting P' to P (preceded by another east step unless P' is the origin). Change this east step into a north step and shift the remainder of the path after P up one unit and left one unit. We now have a path $\phi(\pi)$ from $(0,0)$ to $(n-1, n+1)$, and moreover

$\text{maj}(\sigma(\phi(\pi))) = \text{maj}(\sigma(\pi)) - 1$. For example, if π is the path on the left in Figure 3, then $\phi(\pi)$ is the path on the right.

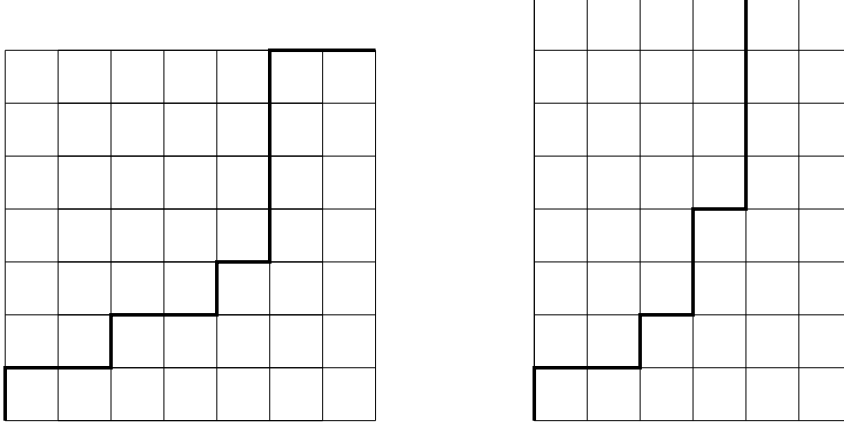

Figure 3: On the left, a path π in $L_{7,7}^-$, with its image $\phi(\pi)$ on the right.

It is easy to see that this map is invertible. Given a lattice path π' from $(0,0)$ to $(n-1, n+1)$, let P' be the point with maximal x -coordinate among those lattice points (i, j) in π' for which $j - i$ is maximal. Thus

$$\sum_{\sigma \in M_{(n,n)}^-} q^{\text{maj}(\sigma)} = \sum_{\sigma' \in M_{(n+1, n-1)}} q^{\text{maj}(\sigma') + 1} = q \begin{bmatrix} 2n \\ n+1 \end{bmatrix}, \quad (15)$$

using (9). Hence

$$\sum_{\pi \in L_{n,n}^+} q^{\text{maj}(\sigma(\pi))} = \sum_{\sigma \in M_{(n,n)}} q^{\text{maj}(\sigma)} - \sum_{\sigma \in M_{(n,n)}^-} q^{\text{maj}(\sigma)} \quad (16)$$

$$= \begin{bmatrix} 2n \\ n \end{bmatrix} - q \begin{bmatrix} 2n \\ n+1 \end{bmatrix} = \frac{1}{[n+1]} \begin{bmatrix} 2n \\ n \end{bmatrix}. \quad (17)$$

□

The second natural q -analogue of C_n was studied by Carlitz and Riordan [CR64]. They define

$$C_n(q) = \sum_{\pi \in L_{n,n}^+} q^{\text{area}(\pi)}. \quad (18)$$

For example, the paths in $L_{3,3}^+$ given in Figure 4 have area, from left-to-right, 3, 2, 1, 1, 0, so $C_3(q) = 1 + 2q + q^2 + q^3$.

Proposition 2

$$C_n(q) = \sum_{k=1}^n q^{k-1} C_{k-1}(q) C_{n-k}(q), \quad n \geq 1. \quad (19)$$

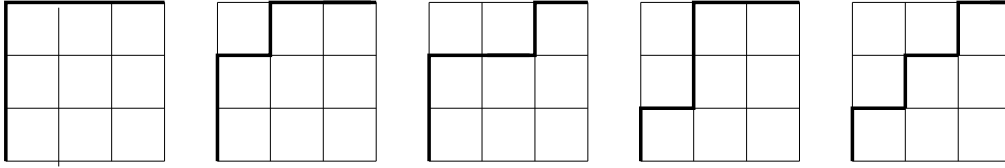

Figure 4: The paths in $L_{3,3}^+$ have Carlitz-Riordan area weights $q^3, q^2, q, q, 1$.

Proof. As in the proof of (13), we break up our path π according to the “point of first return” to the line $y = x$. If this occurs at (k, k) , then the area of the part of π from $(0, 1)$ to $(k - 1, k)$, when viewed as an element of $L_{k-1, k-1}^+$, is $k - 1$ less than the area of this portion of π when viewed as a path in $L_{n, n}^+$. \square

Exercise 2 Define a co-inversion of σ to be a pair (i, j) with $i < j$ and $\sigma_i < \sigma_j$. Show

$$C_n(q) = \sum_{\pi \in L_{n, n}^+} q^{\text{coinv}(\sigma(\pi)) - \binom{n+1}{2}}, \quad (20)$$

where $\text{coinv}(\sigma)$ is the number of co-inversions of σ .

The q -Vandermonde Convolution

Let

$${}_{p+1}\phi_p \left(\begin{matrix} a_1, & a_2, & \dots, & a_{p+1} \\ & b_1, & \dots, & b_p \end{matrix} ; q; z \right) = \sum_{k=0}^{\infty} \frac{(a_1)_k \cdots (a_{p+1})_k}{(q)_k (b_1)_k \cdots (b_p)_k} z^k \quad (21)$$

denote the basic hypergeometric series. A good general reference for this subject is [GR04]. The following result is known as Cauchy’s q -binomial series.

Theorem 5

$${}_1\phi_0 \left(\begin{matrix} a \\ - \end{matrix} ; q; z \right) = \sum_{n=0}^{\infty} \frac{(a)_n}{(q)_n} z^n = \frac{(az)_{\infty}}{(z)_{\infty}}, \quad |z| < 1, |q| < 1, \quad (22)$$

where $(a; q)_{\infty} = (a)_{\infty} = \prod_{i=0}^{\infty} (1 - aq^i)$.

Proof. The following proof is based on the proof in [GR04, Chap. 1]. Let

$$F(a, z) = \sum_{n=0}^{\infty} \frac{(a)_n}{(q)_n} z^n.$$

Then

$$F(a, z) - F(a, qz) = (1 - a)zF(aq, z) \quad (23)$$

and

$$F(a, z) - F(aq, z) = -azF(aq, z). \quad (24)$$

Eliminating $F(aq, z)$ from (23) and (24) we get

$$F(a, z) = \frac{(1-az)}{(1-z)}F(a, qz).$$

Iterating this n times, then taking the limit as $n \rightarrow \infty$ we get

$$\begin{aligned} F(a, z) &= \lim_{n \rightarrow \infty} \frac{(az; q)_n}{(z; q)_n} F(a, q^n z) \\ &= \frac{(az; q)_\infty}{(z; q)_\infty} F(a, 0) = \frac{(az; q)_\infty}{(z; q)_\infty}. \end{aligned} \quad (25)$$

□

Corollary 1 *The q -binomial theorem:*

$$\sum_{k=0}^n q^{\binom{k}{2}} \begin{bmatrix} n \\ k \end{bmatrix} z^k = (-z; q)_n \quad (26)$$

and

$$\sum_{k=0}^{\infty} \begin{bmatrix} n+k \\ k \end{bmatrix} z^k = \frac{1}{(z; q)_{n+1}}. \quad (27)$$

Proof. To prove (26), set $a = q^{-n}$ and $z = -zq^n$ in (22) and simplify. To prove (27), let $a = q^{n+1}$ in (22) and simplify. □

For any function $f(z)$, let $f(z)|_{z^k}$ denote the coefficient of z^k in the Maclaurin series for $f(z)$.

Corollary 2

$$\sum_{k=0}^h q^{(n-k)(h-k)} \begin{bmatrix} n \\ k \end{bmatrix} \begin{bmatrix} m \\ h-k \end{bmatrix} = \begin{bmatrix} m+n \\ h \end{bmatrix}. \quad (28)$$

Proof. By (26),

$$\begin{aligned} q^{\binom{h}{2}} \begin{bmatrix} m+n \\ h \end{bmatrix} &= \prod_{k=0}^{m+n-1} (1+zq^k)|_{z^h} \\ &= \prod_{k=0}^{n-1} (1+zq^k) \prod_{j=0}^{m-1} (1+zq^n q^j)|_{z^h} \\ &= \left(\sum_{k=0}^{n-1} q^{\binom{k}{2}} \begin{bmatrix} n \\ k \end{bmatrix} z^k \right) \left(\sum_{j=0}^{m-1} q^{\binom{j}{2}} \begin{bmatrix} m \\ j \end{bmatrix} (zq^n)^j \right) |_{z^h} \\ &= \sum_{k=0}^h q^{\binom{k}{2}} \begin{bmatrix} n \\ k \end{bmatrix} q^{\binom{h-k}{2}} \begin{bmatrix} m \\ h-k \end{bmatrix} (q^n)^{h-k}. \end{aligned}$$

The result now reduces to the identity

$$\binom{k}{2} + \binom{h-k}{2} + n(h-k) - \binom{h}{2} = (n-k)(h-k).$$

□

Corollary 3

$$\sum_{k=0}^h q^{(m+1)k} \begin{bmatrix} n-1+k \\ k \end{bmatrix} \begin{bmatrix} m+h-k \\ h-k \end{bmatrix} = \begin{bmatrix} m+n+h \\ h \end{bmatrix}. \quad (29)$$

Proof. By (27),

$$\begin{aligned} \begin{bmatrix} m+n+h \\ h \end{bmatrix} &= \frac{1}{(z)_{m+n+1}} \Big|_{z^h} \\ &= \frac{1}{(z)_{m+1}} \frac{1}{(zq^{m+1})_n} \Big|_{z^h} \\ &= \left(\sum_{j=0}^h z^j \begin{bmatrix} m+j \\ j \end{bmatrix}_q \right) \left(\sum_{k=0}^h (zq^{m+1})^k \begin{bmatrix} n-1+k \\ k \end{bmatrix}_q \right) \Big|_{z^h} \\ &= \sum_{k=0}^h q^{(m+1)k} \begin{bmatrix} n-1+k \\ k \end{bmatrix} \begin{bmatrix} m+h-k \\ h-k \end{bmatrix}_q. \end{aligned}$$

□

We note that (28) and (29) have alternative, elementary proofs based on q -counting lattice paths. Both identities are special cases of the following result, known as the q -Vandermonde convolution. For a proof see [GR04, Chap. 1].

Theorem 6 *Let $n \in \mathbb{N}$. Then*

$${}_2\phi_1 \left(a, \begin{matrix} q^{-n} \\ c \end{matrix}; q; q \right) = \frac{(c/a)_n}{(c)_n} a^n. \quad (30)$$

Exercise 3 *By reversing summation in (30), show that*

$${}_2\phi_1 \left(a, \begin{matrix} q^{-n} \\ c \end{matrix}; q; cq^n/a \right) = \frac{(c/a)_n}{(c)_n}. \quad (31)$$

Exercise 4 *Show Newton's binomial series*

$$\sum_{n=0}^{\infty} \frac{a(a+1)\cdots(a+n-1)}{n!} z^n = \frac{1}{(1-z)^a}, \quad |z| < 1, \quad a \in \mathbb{R} \quad (32)$$

can be derived from (22) by replacing a by q^a and letting $q \rightarrow 1^-$. For simplicity you can assume $a, z \in \mathbb{R}$.

Symmetric Functions

The Basics

Given $f(x_1, \dots, x_n) \in K[x_1, x_2, \dots, x_n]$ for some field K , and $\sigma \in S_n$, let

$$\sigma f = f(x_{\sigma_1}, \dots, x_{\sigma_n}). \quad (33)$$

We say f is a *symmetric function* if $\sigma f = f$ for all $\sigma \in S_n$. It will be convenient to work with more general functions f depending on countably many indeterminates x_1, x_2, \dots , indicated by $f(x_1, x_2, \dots)$, in which case we view f as a formal power series in the x_i , and say it is a symmetric function if it is invariant under any permutation of the variables. The standard references on this topic are [Sta99, Chap. 7] and [Mac95]. We will often let X_n and X stand for the set of variables $\{x_1, \dots, x_n\}$ and $\{x_1, x_2, \dots\}$, respectively.

We let Λ denote the ring of symmetric functions in x_1, x_2, \dots and Λ^n the vector subspace consisting of symmetric functions which are homogeneous of degree n . The most basic symmetric functions are the monomial symmetric functions, which depend on a partition λ in addition to a set of variables. They are denoted by $m_\lambda(X) = m_\lambda(x_1, x_2, \dots)$. In a symmetric function it is typical to leave off explicit mention of the variables, with a set of variables being understood from context, so $m_\lambda = m_\lambda(X)$. We illustrate these first by means of examples. We let $\text{Par}(n)$ denote the set of partitions of n , and use the notation $\lambda \vdash n$ as an abbreviation for $\lambda \in \text{Par}(n)$.

Example 1

$$\begin{aligned} m_{1,1} &= \sum_{i < j} x_i x_j \\ m_{2,1,1}(X_3) &= x_1^2 x_2 x_3 + x_1 x_2^2 x_3 + x_1 x_2 x_3^2 \\ m_2(X) &= \sum_i x_i^2. \end{aligned}$$

In general, $m_\lambda(X)$ is the sum of all distinct monomials in the x_i whose multiset of exponents equals the multiset of parts of λ . Any element of Λ can be expressed uniquely as a linear combination of the m_λ .

We let 1^n stand for the partition consisting of n parts of size 1. The function m_{1^n} is called the n th *elementary symmetric function*, which we denote by e_n . Then

$$\prod_{i=1}^{\infty} (1 + zx_i) = \sum_{n=0}^{\infty} z^n e_n, \quad e_0 = 1. \quad (34)$$

Another important special case is $m_n = \sum_i x_i^n$, known as the *power-sum symmetric function*, denoted p_n . We also define the *complete homogeneous symmetric functions* h_n , by $h_n = \sum_{\lambda \vdash n} m_\lambda$, or equivalently

$$\frac{1}{\prod_{i=1}^{\infty} (1 - zx_i)} = \sum_{n=0}^{\infty} z^n h_n, \quad h_0 = 1. \quad (35)$$

For $\lambda \vdash n$, we define $e_\lambda = \prod_i e_{\lambda_i}$, $p_\lambda = \prod_i p_{\lambda_i}$, and $h_\lambda = \prod_i h_{\lambda_i}$. For example,

$$\begin{aligned} e_{2,1} &= \sum_{i<j} x_i x_j \sum_k x_k = m_{2,1} + 3m_{1,1,1} \\ p_{2,1} &= \sum_i x_i^2 \sum_j x_j = m_3 + m_{2,1} \\ h_{2,1} &= \left(\sum_i x_i^2 + \sum_{i<j} x_i x_j \right) \sum_k x_k = m_3 + 2m_{2,1} + 3m_{1,1,1}. \end{aligned}$$

Assuming we have at least n variables, it is known that $\{e_\lambda, \lambda \vdash n\}$ forms a basis for Λ^n , and so do $\{p_\lambda, \lambda \vdash n\}$ and $\{h_\lambda, \lambda \vdash n\}$.

Definition 1 *Two simple functions on partitions we will often use are*

$$\begin{aligned} n(\lambda) &= \sum_i (i-1)\lambda_i = \sum_i \binom{\lambda_i}{2} \\ z_\lambda &= \prod_i i^{m_i} m_i!, \end{aligned}$$

where $m_i = m_i(\lambda)$ is the number of parts of λ equal to i . For example, $n(54331) = 4+6+9+4 = 23$, and $z(5433111) = 5 * 4 * 3^2 * 2! * 3! = 2160$.

Exercise 5 *Use (34) and (35) to show that*

$$\begin{aligned} e_n &= \sum_{\lambda \vdash n} \frac{(-1)^{n-\ell(\lambda)} p_\lambda}{z_\lambda}, \\ h_n &= \sum_{\lambda \vdash n} \frac{p_\lambda}{z_\lambda}. \end{aligned}$$

We let ω denote the ring endomorphism $\omega : \Lambda \rightarrow \Lambda$ defined by

$$\omega(p_k) = (-1)^{k-1} p_k. \quad (36)$$

Thus ω is an involution with $\omega(p_\lambda) = (-1)^{|\lambda|-\ell(\lambda)} p_\lambda$, and by Exercise 5, $\omega(e_n) = h_n$, and more generally $\omega(e_\lambda) = h_\lambda$.

For $f \in \Lambda$, the special value $f(1, q, q^2, \dots, q^{n-1})$ is known as the principal specialization (of order n) of f .

Theorem 7

$$e_m(1, q, \dots, q^{n-1}) = q^{\binom{m}{2}} \begin{bmatrix} n \\ m \end{bmatrix}_q \quad (37)$$

$$h_m(1, q, \dots, q^{n-1}) = \begin{bmatrix} n-1+m \\ m \end{bmatrix}_q \quad (38)$$

$$p_m(1, q, \dots, q^{n-1}) = \frac{1 - q^{nm}}{1 - q^m}. \quad (39)$$

Proof. The principal specializations for e_m and h_m follow directly from (26), (27), (34) and (35). \square

Remark 2 *The principal specialization of m_λ doesn't have a particularly simple description, although if ps_n^1 denotes the set of n variables, each equal to 1, then [Sta99, p. 303]*

$$m_\lambda(ps_n^1) = \binom{n}{m_1, m_2, m_3, \dots}, \quad (40)$$

where again m_i is the multiplicity of the number i in the multiset of parts of λ .

Remark 3 Λ is known to be isomorphic to $K[p_1, p_2, \dots]$. Hence, although identities like

$$h_{2,1} = m_3 + 2m_{2,1} + 3m_{1,1,1}$$

appear at first to depend on a set of variables, it is customary to view them as polynomial identities in the p_λ . Since the p_k (in infinitely many variables) are algebraically independent, we can specialize them to whatever we please, forgetting about the original set of variables X .

We define the Hall scalar product, a bilinear form from $\Lambda \times \Lambda$ to \mathbb{Q} , by

$$\langle p_\lambda, p_\beta \rangle = z_\lambda \chi(\lambda = \beta), \quad (41)$$

where for any logical statement L

$$\chi(L) = \begin{cases} 1 & \text{if } L \text{ is true} \\ 0 & \text{if } L \text{ is false.} \end{cases} \quad (42)$$

Clearly $\langle f, g \rangle = \langle g, f \rangle$. Also, $\langle \omega f, \omega g \rangle = \langle f, g \rangle$, which follows from the definition if $f = p_\lambda, g = p_\beta$, and by bilinearity for general f, g since the p_λ form a basis for Λ .

Theorem 8 *The h_λ and the m_β are dual with respect to the Hall scalar product, i.e.*

$$\langle h_\lambda, m_\beta \rangle = \chi(\lambda = \beta). \quad (43)$$

Proof. See [Mac95] or [Sta99]. \square

For any $f \in \Lambda$, and any basis $\{b_\lambda, \lambda \in \text{Par}\}$ of Λ , let $f|_{b_\lambda}$ denote the coefficient of b_λ when f is expressed in terms of the b_λ . Then (43) implies

Corollary 4

$$\langle f, h_\lambda \rangle = f|_{m_\lambda}. \quad (44)$$

2	2		2	3	
1	1	3	1	1	2
2	3		3	3	
1	1	3	1	1	2
2	3		3	3	
1	2	3	1	2	2

Figure 5: Some SSYT of shape $(3, 2)$.

Tableaux and Schur Functions

Given $\lambda, \mu \in \text{Par}(n)$, a semi-standard Young tableaux (or SSYT) of shape λ and weight μ is a filling of the cells of the Ferrers graph of λ with the elements of the multiset $\{1^{\mu_1} 2^{\mu_2} \dots\}$, so that the numbers weakly increase across rows and strictly increase up columns. Let $SSYT(\lambda, \mu)$ denote the set of these fillings, and $K_{\lambda, \mu}$ the cardinality of this set. The $K_{\lambda, \mu}$ are known as the Kostka numbers. Our definition also makes sense if our weight is a weak composition of n , i.e. any finite sequence of nonnegative integers whose sum is n . For example, $K_{(3,2), (2,2,1)} = K_{(3,2), (2,1,2)} = K_{(3,2), (1,2,2)} = 2$ as in Figure 5.

If the Ferrers graph of a partition β is contained in the Ferrers graph of λ , denoted $\beta \subseteq \lambda$, let λ/β refer to the subset of cells of λ which are not in β . This is referred to as a *skew shape*. Define a SSYT of shape λ/β and weight ν , where $|\nu| = |\lambda| - |\beta|$, to be a filling of the cells of λ/β with elements of $\{1^{\nu_1} 2^{\nu_2} \dots\}$, again with weak increase across rows and strict increase up columns. The number of such tableaux is denoted $K_{\lambda/\beta, \nu}$.

Let $w\text{comp}(\mu)$ denote the set of all weak compositions whose multiset of nonzero parts equals the multiset of parts of μ . It follows easily from Figure 5 that $K_{(3,2), \alpha} = 2$ for all $\alpha \in w\text{comp}(2, 2, 1)$. Hence

$$\sum_{\alpha, T} \prod_i x_i^{\alpha_i} = 2m_{(2,2,1)}, \tag{45}$$

where the sum is over all tableaux T of shape $(3, 2)$ and weight some element of $w\text{comp}(2, 2, 1)$.

This is a special case of a more general phenomenon. For $\lambda \in \text{Par}(n)$, define

$$s_\lambda = \sum_{\alpha, T} \prod_i x_i^{\alpha_i}, \tag{46}$$

where the sum is over all weak compositions α of n , and all possible tableaux T of shape λ and weight α . Then

$$s_\lambda = \sum_{\mu \vdash n} K_{\lambda, \mu} m_\mu, \tag{47}$$

i.e. $K_{\lambda,\beta} = K_{\lambda,\alpha}$ for all compositions β, α whose multiset of parts is the same (we leave it to the interested reader to prove this fact bijectively). The s_λ are called *Schur functions*, and are fundamental to the theory of symmetric functions. Two special cases of (47) are $s_n = h_n$ (since $K_{n,\mu} = 1$ for all $\mu \in \text{Par}(n)$) and $s_{1^n} = e_n$ (since $K_{1^n,\mu} = \chi(\mu = 1^n)$).

A SSYT of weight 1^n is called *standard*, or a SYT. The set of SYT of shape λ is denoted $\text{SYT}(\lambda)$. For $(i, j) \in \lambda$, let the *content* of (i, j) , denoted $c(i, j)$, be $i - j$. Also, let $h(i, j)$ denote the “hook length” of (i, j) , defined as the number of cells to the right of (i, j) in row j plus the number of cells above (i, j) in column i plus 1. For example, if $\lambda = (5, 5, 3, 3, 1)$, $h(2, 2) = 6$. It is customary to let f^λ denote the number of SYT of shape λ , i.e. $f^\lambda = K_{\lambda, 1^n}$. There is a beautiful formula for f^λ , namely

$$f^\lambda = \frac{n!}{\prod_{(i,j) \in \lambda} h(i,j)}. \quad (48)$$

Below we list some of the important properties of Schur functions. See [Sta99, Chapter 7] for proofs of these well-known identities, and how (48) can be derived from (49).

Theorem 9 *Let $\lambda, \mu \in \text{Par}$. Then*

1. *The Schur functions are orthonormal with respect to the Hall scalar product, i.e.*

$$\langle s_\lambda, s_\mu \rangle = \chi(\lambda = \mu).$$

Thus for any $f \in \Lambda$,

$$\langle f, s_\lambda \rangle = f|_{s_\lambda}.$$

2. *Action by ω :*

$$\omega(s_\lambda) = s_{\lambda'}.$$

3. *Principal Specialization: For $\lambda \in \text{Par}$,*

$$s_\lambda(1, q, q^2, \dots, q^{n-1}) = q^{n(\lambda)} \prod_{(i,j) \in \lambda} \frac{[n+a-l]}{[a+l+1]}, \quad (49)$$

where for a given square $(i, j) \in \lambda$, we define the coarm a' and coleg l' as in Figure 6 from Section 2.

4. *Cauchy Identities: For any two alphabets of variables X, Y , let XY denote the set of variables $\{x_i y_j\}$. Then*

$$e_n(XY) = \sum_{\lambda \in \text{Par}(n)} s_\lambda(X) s_{\lambda'}(Y) \quad (50)$$

$$h_n(XY) = \sum_{\lambda \in \text{Par}(n)} s_\lambda(X) s_\lambda(Y). \quad (51)$$

Statistics on Tableaux

There is a q -analogue of the Kostka numbers, denoted by $K_{\lambda,\mu}(q)$, which has many applications in representation theory and the combinatorics of tableaux. Originally defined algebraically in an indirect fashion, the $K_{\lambda,\mu}(q)$ are polynomials in q which satisfy $K_{\lambda,\mu}(1) = K_{\lambda,\mu}$. Foulkes [Fou74] conjectured that there should be a statistic $\text{stat}(T)$ on SSYT T of shape λ and weight μ such that

$$K_{\lambda,\mu}(q) = \sum_{T \in \text{SSYT}(\lambda)} q^{\text{stat}(T)}. \quad (52)$$

This conjecture was resolved by Lascoux and Schützenberger [LS78], who found a statistic *charge* to generate these polynomials. Butler [But94] provided a detailed account of their proof, filling in a lot of missing details. A short proof, based on the combinatorial formula for Macdonald polynomials, is contained in [Hag08][Appendix A].

Assume we have a tableau $T \in \text{SSYT}(\lambda, \mu)$ where $\mu \in \text{Par}$. It will be more convenient for us to describe a slight modification of $\text{charge}(T)$, called $\text{cocharge}(T)$, which is defined as $n(\mu) - \text{charge}$. The *reading word* $\text{read}(T)$ of T is obtained by reading the entries in T from left to right in the top row of T , then continuing left to right in the second row from the top of T , etc. For example, the tableau in the upper-left of Figure 5 has reading word 22113. To calculate $\text{cocharge}(T)$, perform the following algorithm on $\text{read}(T)$.

Algorithm 1 1. Start at the end of $\text{read}(T)$ and scan left until you encounter a 1 - say this occurs at spot i_1 , so $\text{read}(T)_{i_1} = 1$. Then start there and scan left until you encounter a 2. If you hit the end of $\text{read}(T)$ before finding a 2, loop around and continue searching left, starting at the end of $\text{read}(T)$. Say the first 2 you find equals $\text{read}(T)_{i_2}$. Now iterate, start at i_2 and search left until you find a 3, etc. Continue in this way until you have found $4, 5, \dots, \mu_1$, with μ_1 occurring at spot i_{μ_1} . Then the first subword of $\text{read}(T)$ is defined to be the elements of the set $\{\text{read}(T)_{i_1}, \dots, \text{read}(T)_{i_{\mu_1}}\}$, listed in the order in which they occur in $\text{read}(T)$ if we start at the beginning of $\text{read}(T)$ and move left to right. For example, if $\text{read}(T) = 21613244153$ then the first subword equals 632415, corresponding to places 3, 5, 6, 8, 9, 10 of $\text{read}(T)$.

Next remove the elements of the first subword from $\text{read}(T)$ and find the first subword of what's left. Call this the second subword. Remove this and find the first subword in what's left and call this the third subword of $\text{read}(T)$, etc. For the word 21613244153, the subwords are 632415, 2143, 1.

2. The value of $\text{charge}(T)$ will be the sum of the values of charge on each of the subwords of $\text{rw}(T)$. Thus it suffices to assume $\text{rw}(T) \in S_m$ for some m , in which case we set

$$\text{cocharge}(\text{rw}(T)) = \text{comaj}(\text{rw}(T)^{-1}),$$

where $\text{read}(T)^{-1}$ is the usual inverse in S_m , with comaj as in (11). (Another way of describing $\text{cocharge}(\text{read}(T))$ is the sum of $m - i$ over all i for which $i + 1$ occurs before i in $\text{read}(T)$.) For example, if $\sigma = 632415$, then $\sigma^{-1} = 532461$ and $\text{cocharge}(\sigma) = 5 + 4 + 1 = 10$, and finally

$$\text{cocharge}(21613244153) = 10 + 4 + 0 = 14.$$

Note that to compute charge, we could create subwords in the same manner, and count $m - i$ for each i with $i + 1$ occurring to the right of i instead of to the left. For $\lambda, \mu \in \text{Par}(n)$ we set

$$\begin{aligned} \tilde{K}_{\lambda, \mu}(q) &= q^{n(\mu)} K_{\lambda, \mu}(1/q) \\ &= \sum_{T \in \text{SSYT}(\lambda, \mu)} q^{\text{cocharge}(T)}. \end{aligned} \tag{53}$$

In addition to the cocharge statistic, there is a major index statistic on SYT which is often useful. Given a SYT T of shape λ , define a descent of T to be a value of i , $1 \leq i < |\lambda|$, for which $i + 1$ occurs in a row above i in T . Let

$$\text{maj}(T) = \sum i \tag{54}$$

$$\text{comaj}(T) = \sum |\lambda| - i, \tag{55}$$

where the sums are over the descents of T . Then [Sta99, p.363]

$$\begin{aligned} s_{\lambda}(1, q, q^2, \dots) &= \frac{1}{(q)_n} \sum_{T \in \text{SYT}(\lambda)} q^{\text{maj}(T)} \\ &= \frac{1}{(q)_n} \sum_{T \in \text{SYT}(\lambda)} q^{\text{comaj}(T)}. \end{aligned} \tag{56}$$

Representation Theory

Let G be a finite group. A (matrix) representation of G is a group homomorphism from G to $GL_n(\mathbb{C})$, the set of invertible $n \times n$ matrices with entries in \mathbb{C} . See [Sag01] and [JL01] for a detailed discussion of the representation theory of the symmetric group and other finite groups. We include an informal discussion of some of the main ideas here, in order to motivate the combinatorial problems we will be discussing.

We will identify a representation with the image of a homomorphism from G to $GL_n(\mathbb{C})$, namely the set of square invertible matrices $\{M(g), g \in G\}$ with the property that

$$M(g)M(h) = M(gh) \quad \text{for all } g, h \in G. \tag{57}$$

On the left-hand-side of (57) we are using ordinary matrix multiplication, and on the right-hand-side, to define gh , multiplication in G . The number of rows of a given $M(g)$ is called the dimension of the representation.

An *action* of G on a set S is a map from $G \times S$ to S , denoted by $g(s)$ for $g \in G$, $s \in S$, which satisfies

$$g(h(s)) = (gh)(s) \quad \forall g, h \in G, s \in S, \tag{58}$$

with $e(s) = s$ for all $s \in S$, where e is the identity in G . Let V be a finite dimensional \mathbb{C} vector space, with basis w_1, w_2, \dots, w_n . Any linear action of G on V makes V into a $\mathbb{C}G$ module. A module is called *irreducible* if it has no submodules other than $\{0\}$ and itself. Maschke's theorem [JL01] says that every nonzero $\mathbb{C}G$ -module V can be expressed as a direct sum of irreducible submodules.

If we form a matrix $M(g)$ whose i th row consists of the coefficients of the w_j when expanding $g(w_i)$ in the w basis, then $\{M(g), g \in G\}$ is a representation of G . In general $\{M(g), g \in G\}$ will depend on the choice of basis, but the trace of the matrices will not. The trace of the matrix $M(g)$ is called the character of the module (under the given action), which we denote $\text{char}(V)$. If $V = \bigoplus_{j=1}^d V_j$, where each V_j is irreducible, then an ordered basis of V can be chosen so that the matrix M will be in block-diagonal form, where the sizes of the blocks are the dimensions of the V_j . Clearly $\text{char}(V) = \sum_{j=1}^d \text{char}(V_j)$. It turns out that there are only a certain number of possible functions which occur as characters of irreducible modules, namely one for each conjugacy class of G . These are called the irreducible characters of G .

In the case $G = S_n$, the conjugacy classes are in one-to-one correspondence with partitions $\lambda \in \text{Par}(n)$, and the irreducible characters are denoted χ^λ . The dimension of a given V_λ with character χ^λ is known to be f^λ . The value of a given $\chi^\lambda(\sigma)$ depends only on the conjugacy class of σ . For the symmetric group the conjugacy class of an element is determined by rearranging the lengths of the disjoint cycles of σ into nonincreasing order to form a partition called the cycle-type of σ . Thus we can talk about $\chi^\lambda(\beta)$, which means the value of χ^λ at any permutation of cycle type β . For example, $\chi^{(n)}(\beta) = 1$ for all $\beta \vdash n$, so $\chi^{(n)}$ is called the trivial character. Also, $\chi^{1^n}(\beta) = (-1)^{n-\ell(\beta)}$ for all $\beta \vdash n$, so χ^{1^n} is called the sign character, since $(-1)^{n-\ell(\beta)}$ is the sign of any permutation of cycle type β .

One reason Schur functions are important in representation theory is the following (see [Sta99, p.347], [Mac95, Chapter 1]).

Theorem 10 *When expanding the p_μ into the s_λ basis, the coefficients are the χ^λ . To be exact*

$$\begin{aligned} p_\mu &= \sum_{\lambda \vdash n} \chi^\lambda(\mu) s_\lambda \\ s_\lambda &= \sum_{\mu \vdash n} z_\mu^{-1} \chi^\lambda(\mu) p_\mu. \end{aligned}$$

Let $\mathbb{C}[X_n] = \mathbb{C}[x_1, \dots, x_n]$. Given $f(x_1, \dots, x_n) \in \mathbb{C}[X_n]$ and $\sigma \in S_n$, then

$$\sigma f = f(x_{\sigma_1}, \dots, x_{\sigma_n}) \tag{59}$$

defines an action of S_n on $\mathbb{C}[X_n]$.

Assume V is a homogeneous subspace of $\mathbb{C}[X_n]$ which can be decomposed as

$$V = \bigoplus_{i=0}^{\infty} V^{(i)}, \tag{60}$$

where $V^{(i)}$ is the subspace consisting of all elements of V which are homogeneous of degree i in the x_j , and is finite dimensional. This gives a *grading* of the space V , and we define the *Hilbert series* $\mathcal{H}(V; q)$ of V to be the sum

$$\mathcal{H}(V; q) = \sum_{i=0}^{\infty} q^i \dim(V^{(i)}), \tag{61}$$

where \dim indicates the dimension as a \mathbb{C} vector space. If in addition V is fixed by the S_n action, we define the *Frobenius series* $\mathcal{F}(V; q)$ of V to be the symmetric function

$$\sum_{i=0}^{\infty} q^i \sum_{\lambda \in \text{Par}(i)} \text{Mult}(\chi^\lambda, V^{(i)}) s_\lambda, \tag{62}$$

where $\text{Mult}(\chi^\lambda, V^{(i)})$ is the multiplicity of the irreducible character χ^λ in the character of $V^{(i)}$ under the action. In other words, if we decompose $V^{(i)}$ into irreducible S_n -submodules, $\text{Mult}(\chi^\lambda, V^{(i)})$ is the number of these submodules whose trace equals χ^λ .

A polynomial in $\mathbb{C}[X_n]$ is *alternating*, or an alternant, if

$$\sigma f = (-1)^{\text{inv}(\sigma)} f \quad \forall \sigma \in S_n. \quad (63)$$

The set of alternants in V forms a subspace called the subspace of alternants, or anti-symmetric elements, denoted V^ϵ . This is also an S_n -submodule of V .

Proposition 3 *The Hilbert series of V^ϵ equals the coefficient of s_{1^n} in the Frobenius series of V , i.e.*

$$\mathcal{H}(V^\epsilon; q) = \langle \mathcal{F}(V; q), s_{1^n} \rangle. \quad (64)$$

Proof. Let B be a basis for $V^{(i)}$ with the property that the matrices $M(\sigma)$ are in block form. Then $b \in B$ is also in $(V^\epsilon)^{(i)}$ if and only if the column of $M(\sigma)$ corresponding to b has entries $(-1)^{\text{inv}(\sigma)}$ on the diagonal and 0's elsewhere, i.e. is a block corresponding to χ^{1^n} . Thus

$$\langle \mathcal{F}(V; q), s_{1^n} \rangle = \sum_{i=0}^{\infty} q^i \dim((V^\epsilon)^{(i)}) = \mathcal{H}(V^\epsilon; q). \quad (65)$$

□

Remark 4 *Since the dimension of the representation corresponding to χ^λ equals f^λ , which by (44) equals $\langle s_\lambda, h_{1^n} \rangle$, we have*

$$\langle \mathcal{F}(V; q), h_{1^n} \rangle = \mathcal{H}(V; q). \quad (66)$$

Example 2 *Since a basis for $\mathbb{C}[X_n]$ can be obtained by taking all possible monomials in the x_i ,*

$$\mathcal{H}(\mathbb{C}[X_n]; q) = (1 - q)^{-n}. \quad (67)$$

Taking into account the S_n -action, it is known [Hai94, Section 1.4] that

$$\begin{aligned} \mathcal{F}(\mathbb{C}[X_n]; q) &= \sum_{\lambda \in \text{Par}(n)} s_\lambda \frac{\sum_{T \in \text{SYT}(\lambda)} q^{\text{maj}(T)}}{(q)_n} \\ &= \sum_{\lambda \in \text{Par}(n)} s_\lambda s_\lambda(1, q, q^2, \dots) = \prod_{i,j} \frac{1}{(1 - q^i x_j z)} \Big|_{z^n}. \end{aligned} \quad (68)$$

The Ring of Coinvariants and the Space of Diagonal Harmonics

The set of symmetric polynomials in the x_i , denoted $\mathbb{C}[X_n]^{S_n}$, which is generated by $1, e_1, \dots, e_n$, is called the *ring of invariants*. The quotient ring $R_n = \mathbb{C}[x_1, \dots, x_n] / \langle e_1, e_2, \dots, e_n \rangle$, or equivalently $\mathbb{C}[x_1, \dots, x_n] / \langle p_1, p_2, \dots, p_n \rangle$, obtained by forming the quotient by the ideal generated by all symmetric polynomials of positive degree, is known as the *ring of coinvariants*.

It is known that R_n is finite dimensional as a \mathbb{C} -vector space, with $\dim(R_n) = n!$, and more generally that

$$\mathcal{H}(R_n; q) = [n]!. \quad (69)$$

E. Artin [Art76] derived a specific basis for R_n , namely the cosets of

$$\left\{ \prod_{1 \leq i \leq n} x_i^{\alpha_i}, 0 \leq \alpha_i \leq i-1 \right\}. \quad (70)$$

Also,

$$\mathcal{F}(R_n; q) = \sum_{\lambda \in \text{Par}(n)} s_\lambda \sum_{T \in \text{SYT}(\lambda)} q^{\text{maj}(T)}, \quad (71)$$

a result that Stanley [Sta79], [Sta03] attributes to unpublished work of Lusztig. This shows the Frobenius series of R_n is $(q)_n$ times the Frobenius series of $\mathbb{C}[X_n]$.

Let

$$V_n = \det \begin{bmatrix} 1 & x_1 & \dots & x_1^{n-1} \\ 1 & x_2 & \dots & x_2^{n-1} \\ & & \vdots & \\ 1 & x_n & \dots & x_n^{n-1} \end{bmatrix} = \prod_{1 \leq i < j \leq n} (x_j - x_i)$$

be the Vandermonde determinant. The *space of harmonics* H_n can be defined as the \mathbb{C} vector space spanned by V_n and its partial derivatives of all orders. Haiman [Hai94] provides a detailed proof that H_n is isomorphic to R_n as an S_n module, and notes that an explicit isomorphism α is obtained by letting $\alpha(h), h \in H_n$, be the element of $\mathbb{C}[X_n]$ represented modulo $\langle e_1, \dots, e_n \rangle$ by h . Thus $\dim(H_n) = n!$ and moreover the character of H_n under the S_n -action is given by (71). He also argues that (71) follows immediately from (68) and the fact that H_n generates $\mathbb{C}[X_n]$ as a free module over $\mathbb{C}[X_n]^{S_n}$.

There is a natural extension of this construction to two sets of variables, which has a very rich algebraic and combinatorial structure. Let the ring of diagonal coinvariants DR_n be defined as

$$DR_n = \mathbb{C}[X_n, Y_n] / \left\langle \sum_{i=1}^n x_i^h y_i^k, \forall h+k > 0 \right\rangle. \quad (72)$$

By analogy we also define the space of diagonal harmonics DH_n by

$$DH_n = \left\{ f \in \mathbb{C}[X_n, Y_n] : \sum_{i=1}^n (\partial x_i)^h (\partial y_i)^k f = 0, \forall h+k > 0 \right\}. \quad (73)$$

Many of the properties of H_n and R_n carry over to two sets of variables. For example the symmetric group acts “diagonally” on DR_n and DH_n by permuting the X and Y variables in the same way, which turns DH_n and DR_n into finite-dimensional isomorphic S_n -modules. We can decompose DH_n by homogeneous X and Y degree, and the S_n action respects this bi-grading. Hence we can talk about the Hilbert series $\mathcal{H}(DH_n; q, t)$ and the Frobenius series $\mathcal{F}(DH_n; q, t)$.

2 The q, t -Catalan Numbers

Given a cell $x \in \lambda$, let the arm $a = a(x)$, leg $l = l(x)$, coarm $a' = a'(x)$, and coleg $l' = l'(x)$ be the number of cells strictly between x and the border of λ in the east, north, west, and south directions, respectively, as in Figure 6. Also, define

$$B_\mu = B_\mu(q, t) = \sum_{x \in \mu} q^{a'} t^{l'}, \quad \Pi_\mu = \Pi_\mu(q, t) = \prod'_{x \in \mu} (1 - q^{a'} t^{l'}), \quad (74)$$

where a prime symbol $'$ above a product or a sum over cells of a partition μ indicates we ignore the corner $(1, 1)$ cell, and $B_\emptyset = 0$, $\Pi_\emptyset = 1$. For example, $B_{(2,2,1)} = 1 + q + t + qt + t^2$ and $\Pi_{(2,2,1)} = (1 - q)(1 - t)(1 - qt)(1 - t^2)$. Note that

$$n(\mu) = \sum_{x \in \mu} l' = \sum_{x \in \mu} l. \quad (75)$$

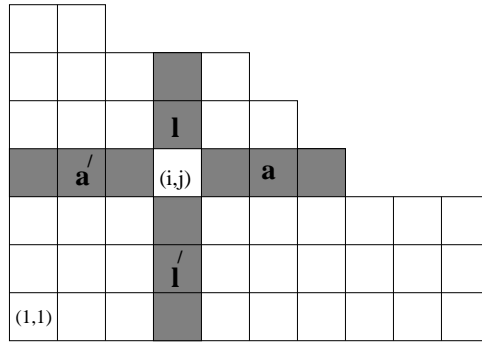

Figure 6: The arm a , coarm a' , leg l , and coleg l' of a cell.

In 1996 Garsia and Haiman [GH96] introduced an amazing two-parameter Catalan sequence, $C_n(q, t)$, which they defined as the following sum of rational functions:

$$C_n(q, t) = \sum_{\mu \vdash n} \frac{T_\mu^2 M \Pi_\mu B_\mu}{w_\mu}, \quad (76)$$

where

$$M = (1 - q)(1 - t), \quad T_\mu = t^{n(\mu)} q^{n(\mu')}, \quad w_\mu = \prod_{x \in \mu} (q^a - t^{l+1})(t^l - q^{a+1}). \quad (77)$$

The definition of $C_n(q, t)$ was motivated by ideas involving algebraic geometry, and Garsia and Haiman conjectured that $C_n(q, t) \in \mathbb{N}[q, t]$. More specifically, they conjectured that $C_n(q, t)$ is the sign character in the Frobenius series for DH_n , i.e.

$$C_n(q, t) = \langle \mathcal{F}(DH_n; q, t), s_{1^n} \rangle. \quad (78)$$

Mark Haiman proved this conjecture in 2001 by obtaining the following expression for $\mathcal{F}(DH_n; q, t)$ in terms of Macdonald polynomials.

Theorem 11 [Hai02]

$$\mathcal{F}(DH_n; q, t) = \sum_{\mu \vdash n} \frac{T_\mu M \Pi_\mu B_\mu \tilde{H}_\mu(X; q, t)}{w_\mu}, \quad (79)$$

where the $\tilde{H}_\mu(X; q, t)$ form the modified Macdonald polynomial symmetric function basis. Although we will not describe these polynomials explicitly here, the interested reader can find a combinatorial description of them in [HHL05a] or [Hag08][Appendix A].

We mention that

$$\langle \tilde{H}_\mu(X; q, t), s_{1^n}(X) \rangle = T_\mu, \quad (80)$$

so (79) implies (78). The right-hand-side of (79) can be expressed more compactly as $\nabla e_n(X)$, where ∇ is the linear operator on symmetric functions satisfying

$$\nabla \tilde{H}_\mu(X; q, t) = T_\mu \tilde{H}_\mu(X; q, t). \quad (81)$$

Hence we can refer to $\mathcal{F}(DH_n; q, t)$ and ∇e_n interchangeably.

Around the same time Haiman proved Theorem 11, Garsia and Haglund proved independently that $C_n(q, t)$ can be expressed combinatorially in terms of statistics on Dyck paths which we now describe.

The Bounce Statistic

Our combinatorial formula for $C_n(q, t)$, the q, t -Catalan number, involves a new statistic on Dyck paths we call *bounce*.

Definition 2 Given $\pi \in L_{n,n}^+$, define the bounce path of π to be the path described by the following algorithm.

Start at $(0, 0)$ and travel North along π until you encounter the beginning of an *E* step. Then turn East and travel straight until you hit the diagonal $y = x$. Then turn North and travel straight until you again encounter the beginning of an *E* step of π , then turn East and travel to the diagonal, etc. Continue in this way until you arrive at (n, n) .

We can think of our bounce path as describing the trail of a billiard ball shot North from $(0, 0)$, which “bounces” right whenever it encounters a horizontal step and “bounces” up when it encounters the line $y = x$. The bouncing ball will strike the diagonal at places

$$(0, 0), (j_1, j_1), (j_2, j_2), \dots, (j_{b-1}, j_{b-1}), (j_b, j_b) = (n, n)$$

. We define the bounce statistic $\text{bounce}(\pi)$ to be the sum

$$\text{bounce}(\pi) = \sum_{i=1}^{b-1} n - j_i, \quad (82)$$

and we call b the number of bounces, with j_1 the length of the first bounce, $j_2 - j_1$ the length of the second bounce, etc. The lattice points where the bouncing billiard ball switches from traveling North to East are called the peaks of π . The first peak is the peak with smallest y coordinate, the second peak the one with next smallest y coordinate, etc. For example, for the path π in Figure 7, there are 5 bounces of lengths 3, 2, 2, 3, 1 and $\text{bounce}(\pi) = 19$. The first two peaks have coordinates $(0, 3)$ and $(3, 5)$.

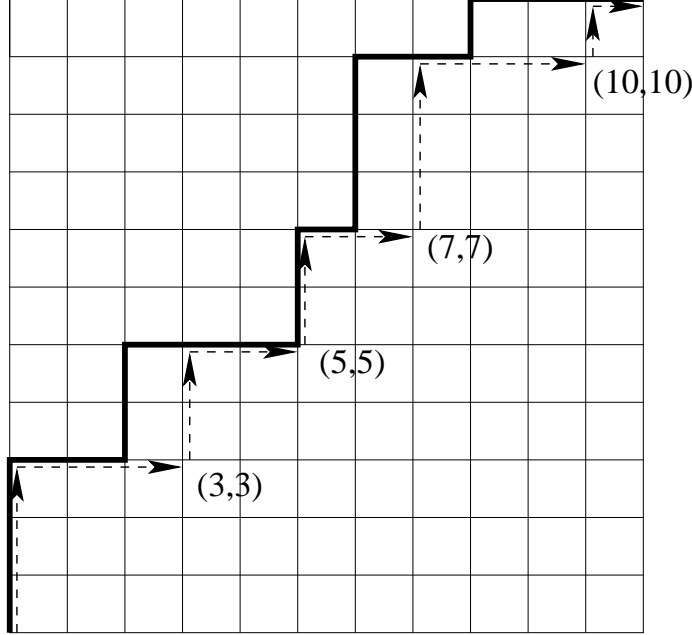

Figure 7: The bounce path (dotted line) of a Dyck path (solid line). The bounce statistic equals $11 - 3 + 11 - 5 + 11 - 7 + 11 - 10 = 8 + 6 + 4 + 1 = 19$.

Let

$$F_n(q, t) = \sum_{\pi \in L_{n,n}^+} q^{\text{area}(\pi)} t^{\text{bounce}(\pi)}. \quad (83)$$

Theorem 12

$$C_n(q, t) = F_n(q, t). \quad (84)$$

Combining Theorem 12 with Theorem 11 we have the following.

Corollary 5

$$\mathcal{H}(DH_n^\epsilon; q, t) = \sum_{\pi \in L_{n,n}^+} q^{\text{area}(\pi)} t^{\text{bounce}(\pi)}. \quad (85)$$

Theorem 12 was first Conjectured by Haglund in 2000 [Hag03] after a prolonged study of tables of $C_n(q, t)$. It was then proved by Garsia and Haglund [GH01], [GH02]. At the present time there is no known way of proving Corollary 5 without using both Theorems 12 and 11.

The proof of Theorem 12 is based on a recursive structure underlying $F_n(q, t)$.

Definition 3 Let $L_{n,n}^+(k)$ denote the set of all $\pi \in L_{n,n}^+$ which begin with exactly k N steps followed by an E step. By convention $L_{0,0}^+(k)$ consists of the empty path if $k = 0$ and is empty otherwise. Set

$$F_{n,k}(q, t) = \sum_{\pi \in L_{n,n}^+(k)} q^{\text{area}(\pi)} t^{\text{bounce}(\pi)}, \quad F_{n,0} = \chi(n = 0). \quad (86)$$

Theorem 13 [Hag03]. For $1 \leq k \leq n$,

$$F_{n,k}(q, t) = \sum_{r=0}^{n-k} \begin{bmatrix} r+k-1 \\ r \end{bmatrix}_q t^{n-k} q^{\binom{k}{2}} F_{n-k,r}(q, t). \quad (87)$$

Proof. Given $\beta \in L_{n,n}^+(k)$, with first bounce k and second bounce say r , then β must pass through the lattice points with coordinates $(1, k)$ and $(k, k+r)$ (the two large dots in Figure 8). Decompose β into two parts, the first part being the portion of β starting at $(0, 0)$ and ending at $(k, k+r)$, and the second the portion starting at $(k, k+r)$ and ending at (n, n) . If we adjoin a sequence of r N steps to the beginning of the second part, we obtain a path β' in $L_{n-k, n-k}^+(r)$. It is easy to check that $\text{bounce}(\beta) = \text{bounce}(\beta') + n - k$. It remains to relate $\text{area}(\beta)$ and $\text{area}(\beta')$.

Clearly the area inside the triangle below the first bounce step is $\binom{k}{2}$. If we fix β' , and let β vary over all paths in $L_{n,n}^+(k)$ which travel through $(1, k)$ and $(k, k+r)$, then the sum of $q^{\text{area}(\beta)}$ will equal

$$q^{\text{area}(\beta')} q^{\binom{k}{2}} \begin{bmatrix} k+r-1 \\ r \end{bmatrix}_q \quad (88)$$

by (6). Thus

$$F_{n,k}(q, t) = \sum_{r=0}^{n-k} \sum_{\beta' \in L_{n-k, n-k}^+(r)} q^{\text{area}(\beta')} t^{\text{bounce}(\beta')} t^{n-k} q^{\binom{k}{2}} \begin{bmatrix} k+r-1 \\ r \end{bmatrix}_q \quad (89)$$

$$= \sum_{r=0}^{n-k} \begin{bmatrix} r+k-1 \\ r \end{bmatrix}_q t^{n-k} q^{\binom{k}{2}} F_{n-k,r}(q, t). \quad (90)$$

□

Corollary 6

$$F_n(q, t) = \sum_{b=1}^n \sum_{\substack{\alpha_1 + \alpha_2 + \dots + \alpha_b = n \\ \alpha_i > 0}} t^{\alpha_2 + 2\alpha_3 + \dots + (b-1)\alpha_b} q^{\sum_{i=1}^b \binom{\alpha_i}{2}} \prod_{i=1}^{b-1} \begin{bmatrix} \alpha_i + \alpha_{i+1} - 1 \\ \alpha_{i+1} \end{bmatrix}_q, \quad (91)$$

where the inner sum is over all compositions α of n into b positive integers.

Proof. This follows by iterating the recurrence in Theorem 13. The inner term in the sum over b equals the sum of $q^{\text{area}} t^{\text{bounce}}$ over all paths π whose bounce path has b steps of lengths $\alpha_1, \dots, \alpha_b$. For such a π , the contribution of the first bounce to $\text{bounce}(\pi)$ is $n - \alpha_1 = \alpha_2 + \dots + \alpha_b$, the contribution of the second bounce is $n - \alpha_1 - \alpha_2 = \alpha_3 + \dots + \alpha_b$, et cetera, so $\text{bounce}(\pi) = \alpha_2 + 2\alpha_3 + \dots + (b-1)\alpha_b$. □

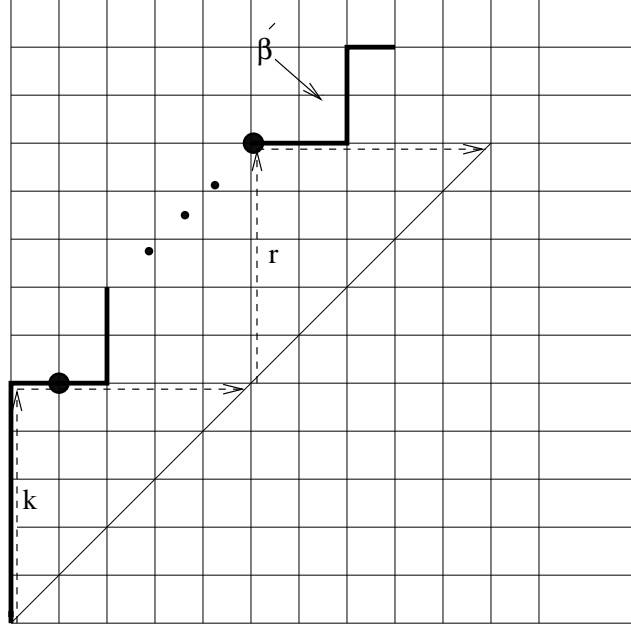

Figure 8: A path whose first two bounce steps are k and r .

The Special Values $t = 1$ and $t = 1/q$

Garsia and Haiman proved that

$$C_n(q, 1) = C_n(q) \quad (92)$$

$$q^{\binom{n}{2}} C_n(q, 1/q) = \frac{1}{[n+1]} \begin{bmatrix} 2n \\ n \end{bmatrix}_q, \quad (93)$$

which shows that both the Carlitz-Riordan and MacMahon q -Catalan numbers are special cases of $C_n(q, t)$. In this section we derive analogous results for $F_{n,k}(q, 1)$ and $F_{n,k}(q, 1/q)$.

By definition we have

$$F_n(q, 1) = C_n(q). \quad (94)$$

It is perhaps worth mentioning that the $F_{n,k}(q, 1)$ satisfy the simple recurrence

$$F_{n,k}(q, 1) = \sum_{m=k}^n q^{m-1} F_{m-1, k-1}(q, 1) F_{n-m}(q, 1). \quad (95)$$

This follows by grouping paths in $L_{n,n}^+(k)$ according to the first time they return to the diagonal, at say (m, m) , then arguing as in the proof of Proposition 19.

The $F_{n,k}(q, 1/q)$ satisfy the following refinement of (93).

Theorem 14 For $1 \leq k \leq n$,

$$q^{\binom{n}{2}} F_{n,k}(q, 1/q) = \frac{[k]}{[n]} \begin{bmatrix} 2n - k - 1 \\ n - k \end{bmatrix}_q q^{(k-1)n}. \quad (96)$$

Proof. Since $F_{n,n}(q, t) = q^{\binom{n}{2}}$, Theorem 14 holds for $k = n$. If $1 \leq k < n$, we start with Theorem 13 and then use induction on n :

$$q^{\binom{n}{2}} F_{n,k}(q, q^{-1}) = q^{\binom{n}{2}} q^{-\binom{n-k}{2}} \sum_{r=1}^{n-k} q^{\binom{n-k}{2}} F_{n-k,r}(q, q^{-1}) q^{\binom{k}{2} - (n-k)} \begin{bmatrix} r+k-1 \\ r \end{bmatrix}_q \quad (97)$$

$$= q^{\binom{n}{2} + \binom{k}{2} - (n-k)} q^{-\binom{n-k}{2}} \sum_{r=1}^{n-k} \begin{bmatrix} r+k-1 \\ r \end{bmatrix}_q \frac{[r]}{[n-k]} \begin{bmatrix} 2(n-k) - r - 1 \\ n-k-r \end{bmatrix}_q q^{(r-1)(n-k)} \quad (98)$$

$$= q^{(k-1)n} \sum_{r=1}^{n-k} \begin{bmatrix} r+k-1 \\ r \end{bmatrix}_q \frac{[r]}{[n-k]} \begin{bmatrix} 2(n-k) - 2 - (r-1) \\ n-k-1 - (r-1) \end{bmatrix}_q q^{(r-1)(n-k)} \quad (99)$$

$$= q^{(k-1)n} \frac{[k]}{[n-k]} \sum_{u=0}^{n-k-1} \begin{bmatrix} k+u \\ u \end{bmatrix}_q q^{u(n-k)} \begin{bmatrix} 2(n-k) - 2 - u \\ n-k-1-u \end{bmatrix}_q. \quad (100)$$

Using (27) we can write the right-hand side of (100) as

$$q^{(k-1)n} \frac{[k]}{[n-k]} \frac{1}{(zq^{n-k})_{k+1}} \frac{1}{(z)_{n-k}} \Big|_{z^{n-k-1}} = q^{(k-1)n} \frac{[k]}{[n-k]} \frac{1}{(z)_{n+1}} \Big|_{z^{n-k-1}} \quad (101)$$

$$= q^{(k-1)n} \frac{[k]}{[n-k]} \begin{bmatrix} n+n-k-1 \\ n \end{bmatrix}_q. \quad (102)$$

□

Corollary 7

$$q^{\binom{n}{2}} F_n(q, 1/q) = \frac{1}{[n+1]} \begin{bmatrix} 2n \\ n \end{bmatrix}_q. \quad (103)$$

Proof. N. Loehr has pointed out that we can use

$$F_{n+1,1}(q, t) = t^n F_n(q, t), \quad (104)$$

which by Theorem 14 implies

$$\begin{aligned} q^{\binom{n+1}{2}} F_{n+1,1}(q, 1/q) &= \frac{[1]}{[n+1]} \begin{bmatrix} 2(n+1) - 2 \\ n+1-1 \end{bmatrix}_q = \frac{[1]}{[n+1]} \begin{bmatrix} 2n \\ n \end{bmatrix}_q \\ &= q^{\binom{n+1}{2} - n} F_n(q, 1/q) = q^{\binom{n}{2}} F_n(q, 1/q). \end{aligned} \quad (105)$$

□

The Symmetry Problem and the $\text{div}v$ Statistic

From its definition, it is easy to show $C_n(q, t) = C_n(t, q)$, since the arm and leg values for μ equal the leg and arm values for μ' , respectively, which implies q and t are interchanged when comparing terms in (76) corresponding to μ and μ' . This also follows from the theorem that $C_n(q, t) = \mathcal{H}(DH_n^e; q, t)$. Thus we have

$$\sum_{\pi \in L_{n,n}^+} q^{\text{area}(\pi)} t^{\text{bounce}(\pi)} = \sum_{\pi \in L_{n,n}^+} q^{\text{bounce}(\pi)} t^{\text{area}(\pi)}, \quad (106)$$

a surprising statement in view of the apparent dissimilarity of the area and bounce statistics. At present there is no other known way to prove (106) other than as a corollary of Theorem 12.

Open Problem 1 *Prove (106) by exhibiting a bijection on Dyck paths which interchanges area and bounce.*

A solution to Problem 1 should lead to a deeper understanding of the combinatorics of DH_n . We now give a combinatorial proof from [Hag03] of a very special case of (106), by showing that the marginal distributions of area and bounce are the same, i.e. $F_n(q, 1) = F_n(1, q)$.

Theorem 15

$$\sum_{\pi \in L_{n,n}^+} q^{\text{area}(\pi)} = \sum_{\pi \in L_{n,n}^+} q^{\text{bounce}(\pi)}. \quad (107)$$

Proof. Given $\pi \in L_{n,n}^+$, let $a_1 a_2 \cdots a_n$ denote the sequence whose i th element is the i th coordinate of the area vector of π , i.e. the length of the i th row (from the bottom) of π . A moment's thought shows that such a sequence is characterized by the property that it begins with zero, consists of n nonnegative integers, and has no 2-ascents, i.e. values of i for which $a_{i+1} > a_i + 1$. To construct such a sequence we begin with an arbitrary multiset of row lengths, say $\{0^{\alpha_1} 1^{\alpha_2} \cdots (b-1)^{\alpha_b}\}$ and then choose a multiset permutation τ of $\{0^{\alpha_1} 1^{\alpha_2}\}$ which begins with 0 in $\binom{\alpha_1 - 1 + \alpha_2}{\alpha_2}$ ways. Next we will insert the α_3 twos into τ , the requirement of having no 2-ascents translating into having no consecutive 02 pairs. This means the number of ways to do this is $\binom{\alpha_2 - 1 + \alpha_3}{\alpha_3}$, independent of the choice of τ . The formula

$$F_n(q, 1) = \sum_{b=1}^n \sum_{\substack{\alpha_1 + \cdots + \alpha_b = n \\ \alpha_i > 0}} q^{\sum_{i=2}^b \alpha_i (i-1)} \prod_{i=1}^{b-1} \binom{\alpha_i - 1 + \alpha_{i+1}}{\alpha_{i+1}} \quad (108)$$

follows, since the product above counts the number of Dyck paths with a specified multiset of row lengths, and the power of q is the common value of area for all these paths. Comparing (108) with the $q = 1, t = q$ case of (91) completes the proof. \square

There is another pair of statistics for the q, t -Catalan discovered by M. Haiman [Hai00]. It involves pairing area with a different statistic we call dinv , for “diagonal inversion” or “ d -inversion”. It is defined, with a_i the length of the i th row from the bottom, as follows.

Definition 4 *Let $\pi \in L_{n,n}^+$. Let*

$$\begin{aligned} \text{dinv}(\pi) = & |\{(i, j) : 1 \leq i < j \leq n \quad a_i = a_j\}| \\ & + |\{(i, j) : 1 \leq i < j \leq n \quad a_i = a_j + 1\}|. \end{aligned}$$

In words, $\text{dinv}(\pi)$ is the number of pairs of rows of π of the same length, or which differ by one in length, with the longer row below the shorter. For example, for the path on the left in Figure 9, with row lengths on the right, the inversion pairs (i, j) are $(3, 7), (4, 7), (5, 7), (6, 8)$ (corresponding to rows which differ by one in length) and $(2, 7), (3, 4), (3, 5), (3, 8), (4, 5), (4, 8), (5, 8)$ (corresponding to pairs of rows of the same length), thus $\text{dinv} = 11$. We call inversion pairs between rows of the same length “equal-length” inversions, and the other kind “offset-length” inversions.

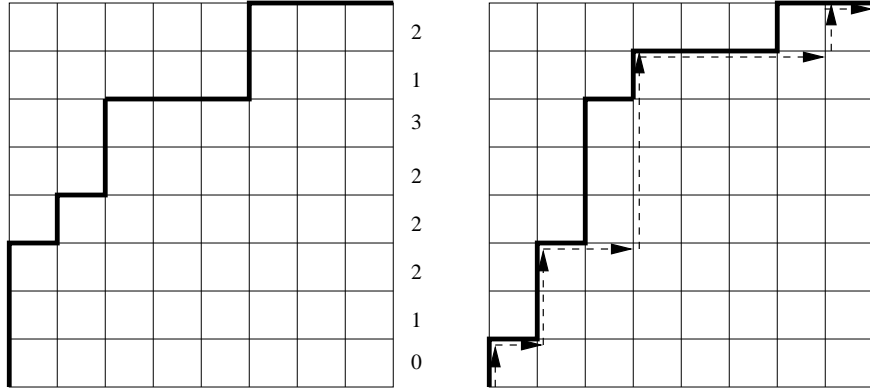

Figure 9: A path π with row lengths to the right, and the image $\zeta(\pi)$.

Theorem 16

$$\sum_{\pi \in L_{n,n}^+} q^{\text{dinv}(\pi)} t^{\text{area}(\pi)} = \sum_{\pi \in L_{n,n}^+} q^{\text{area}(\pi)} t^{\text{bounce}(\pi)}. \quad (109)$$

Proof. We will describe a bijective map ζ on Dyck paths with the property that

$$\begin{aligned} \text{dinv}(\pi) &= \text{area}(\zeta(\pi)) \\ \text{area}(\pi) &= \text{bounce}(\zeta(\pi)). \end{aligned} \quad (110)$$

Say $b - 1$ is the length of the longest row of π . The lengths of the bounce steps of ζ will be $\alpha_1, \dots, \alpha_b$, where α_i is the number of rows of length $i - 1$ in π . To construct the actual path ζ , place a pen at the lattice point $(\alpha_1, \alpha_1 + \alpha_2)$ (the second peak of the bounce path of ζ). Start at the end of the area sequence and travel left. Whenever you encounter a 1, trace a South step with your pen. Whenever you encounter a 0, trace a West step. Skip over all other numbers. Your pen will end up at the top of the first peak of ζ . Now go back to the end of the area sequence, and place your pen at the top of the third peak. Traverse the area sequence again from right to left, but this time whenever you encounter a 2 trace out a South step, and whenever you encounter a 1, trace out a West step. Skip over any other numbers. Your pen will end up at the top of the second peak of ζ . Continue at the top of the fourth peak looking at how the rows of length 3 and 2 are interleaved, etc.. See Figure 9.

It is easy to see this map is a bijection, since given ζ , from the bounce path we can determine the multiset of row lengths of π . We can then build up the area sequence of π just as in the proof of Theorem 15. From the portion of the path between the first and second peaks we can see how to interleave the rows of lengths 0 and 1, and then we can insert the rows of length 2 into the area sequence, etc.

Note that when tracing out the part of ζ between the first and second peaks, whenever we encounter a 0 and trace out a West step, the number of area squares directly below this West step and above the bounce path of ζ equals the number of 1's to the left of this 0 in the area sequence, which is the number of offset-length inversion pairs involving the corresponding row of length 0. Since the area below the bounce path clearly counts the total number of equal-length inversions, it follows that $\text{dinv}(\pi) = \text{area}(\zeta(\pi))$.

Now by direct calculation,

$$\begin{aligned} \text{bounce}(\zeta) &= n - \alpha_1 + n - \alpha_1 - \alpha_2 + \dots n - \alpha_1 - \dots - \alpha_{b-1} \\ &= (\alpha_2 + \dots + \alpha_b) + \dots + (\alpha_b) = \sum_{i=1}^{b-1} i\alpha_{i+1} = \text{area}(\pi). \end{aligned} \tag{111}$$

□

Remark 5 *The construction of the bounce path for a Dyck path occurs in an independent context, in work of Andrews, Krattenthaler, Orsina and Papi [AKOP02] on the enumeration of ad-nilpotent ideals of a Borel subalgebra of $\mathfrak{sl}(n+1, \mathbb{C})$. They prove the number of times a given nilpotent ideal needs to be bracketed with itself to become zero equals the number of bounces of the bounce path of a certain Dyck path associated to the ideal. Another of their results is a bijective map on Dyck paths which sends a path with b bounces to a path whose longest row is of length $b-1$. The ζ map above is just the inverse of their map. Because they only considered the number of bounces, and not the bounce statistic per se, they did not notice any connection between $C_n(q, t)$ and their construction.*

Theorem 12 now implies

Corollary 8

$$C_n(q, t) = \sum_{\pi \in L_{n,n}^+} q^{\text{div}(\pi)} t^{\text{area}(\pi)}. \tag{112}$$

We also have

$$F_{n,k}(q, t) = \sum_{\substack{\pi \in L_{n,n}^+ \\ \pi \text{ has exactly } k \text{ rows of length } 0}} q^{\text{div}(\pi)} t^{\text{area}(\pi)}, \tag{113}$$

since under the ζ map, paths with k rows of length 0 correspond to paths whose first bounce step is of length k .

Remark 6 *N. Loehr has noted that if one can find a map which fixes area and sends bounce to div , by combining this with the ζ map one would have a map which interchanges area and div , solving Problem 1.*

Exercise 6 *Let*

$$G_{n,k}(q, t) = \sum_{\substack{\pi \in L_{n,n}^+ \\ \pi \text{ has exactly } k \text{ rows of length } 0}} q^{\text{div}(\pi)} t^{\text{area}(\pi)}. \tag{114}$$

Without referencing any results on the bounce statistic, prove combinatorially that

$$G_{n,k}(q, t) = t^{n-k} q^{\binom{k}{2}} \sum_{r=0}^{n-k} \begin{bmatrix} r+k-1 \\ r \end{bmatrix}_q G_{n-k,r}(q, t). \tag{115}$$

Exercise 7 *Haiman's conjectured statistics for $C_n(q, t)$ actually involved a different description of din_v . Let $\lambda(\pi)$ denote the partition consisting of the $\binom{n}{2} - \text{area}(\pi)$ squares above π but inside the $n \times n$ square. (This is the Ferrers graph of a partition in the so-called English convention, which is obtained from the French convention of Figure 1 by reflecting the graph about the x -axis. In this convention, the leg $l(s)$ of a square s is defined as the number of squares of λ below s in the column and above the lower border π , and the arm $a(s)$ as the number of squares of λ to the right and in the row.) Then Haiman's original version of din_v was the number of cells s of λ for which*

$$l(s) \leq a(s) \leq l(s) + 1. \quad (116)$$

Prove this definition of din_v is equivalent to Definition 4.

q-Lagrange Inversion

q -Lagrange inversion is useful when analyzing the special case $t = 1$ of $\mathcal{F}(DH_n; q, t)$. In this section we derive a general q -Lagrange inversion theorem based on work of Garsia and Haiman. We will be working in the ring of formal power series, and we begin with a result of Garsia [Gar81].

Theorem 17 *If*

$$(F \circ_q G)(z) = \sum_n f_n G(z) G(qz) \cdots G(q^{n-1}z), \quad (117)$$

where $F = \sum_n f_n z^n$, then for F and G without constant term,

$$F \circ_q G = z \text{ and } G \circ_{q^{-1}} F = z \quad (118)$$

are equivalent to each other and also to

$$(\Phi \circ_{q^{-1}} F) \circ_q G = \Phi = (\Phi \circ_q G) \circ_{q^{-1}} F \quad \text{for all } \Phi. \quad (119)$$

Given $\pi \in L_{n,n}^+$, let $\beta(\pi) = \beta_1(\pi)\beta_2(\pi)\cdots$ denote the partition consisting of the vertical step lengths of π (i.e. the lengths of the maximal blocks of consecutive 0's in $\sigma(\pi)$), arranged in nonincreasing order. For example, for the path on the left in Figure 9 we have $\beta = (3, 2, 2, 1)$. By convention we set $\beta(\emptyset) = \emptyset$. Define $H(z)$ via the equation $1/H(-z) := \sum_{k=0}^{\infty} e_k z^k$. Using Theorem 17, Haiman [Hai94, pp. 47-48] derived the following.

Theorem 18 *There is a unique solution $h_n^*(q)$, $n \geq 0$ to the equation*

$$\sum_{k=0}^{\infty} e_k z^k = \sum_{n=0}^{\infty} q^{-\binom{n}{2}} h_n^*(q) z^n H(-q^{-1}z) H(-q^{-2}z) \cdots H(-q^{-n}z), \quad h_0^*(q) = 1. \quad (120)$$

For $n > 0$, $h_n^(q)$ has the explicit expression*

$$h_n^*(q) = \sum_{\pi \in L_{n,n}^+} q^{\text{area}(\pi)} e_{\beta(\pi)}. \quad (121)$$

For example, we have

$$h_3^*(q) = q^3 e_3 + q^2 e_{2,1} + 2q e_{2,1} + e_{1^3}. \quad (122)$$

We now derive a slight generalization of Theorem 18 which stratifies Dyck paths according to the length of their first bounce step.

Theorem 19 *Let $c_k, k \geq 0$ be a set of variables. Define $h_n^*(\mathbf{c}, q)$, $n \geq 0$ via the equation*

$$\sum_{k=0}^{\infty} e_k c_k z^k = \sum_{n=0}^{\infty} q^{-\binom{n}{2}} h_n^*(\mathbf{c}, q) z^n H(-q^{-1}z) H(-q^{-2}z) \cdots H(-q^{-n}z), \quad h_0^*(\mathbf{c}q) = c_0. \quad (123)$$

Then for $n \geq 0$, $h_n^*(\mathbf{c}, q)$ has the explicit expression

$$h_n^*(\mathbf{c}, q) = \sum_{k=0}^n c_k \sum_{\pi \in L_{n,n}^+(k)} q^{\text{area}(\pi)} e_{\beta(\pi)}. \quad (124)$$

For example, we have

$$h_3^*(\mathbf{c}, q) = q^3 e_3 c_3 + (q^2 e_{2,1} + q e_{2,1}) c_2 + (q e_{2,1} + e_{1^3}) c_1. \quad (125)$$

Proof. Our proof follows Haiman's proof of Theorem 18 closely. Set $H^*(z, \mathbf{c}; q) := \sum_{n=0}^{\infty} h_n^*(\mathbf{c}, q) z^n$, $H^*(z; q) := \sum_{n=0}^{\infty} h_n^*(q) z^n$, $\Phi = H^*(zq, \mathbf{c}; q)$, $F = zH(-z)$, and $G = zH^*(qz; q)$. Replacing z by zq in (123) we see that Theorem 19 is equivalent to the statement

$$\begin{aligned} \sum_{k=0}^{\infty} e_k c_k q^k z^k &= \sum_{n=0}^{\infty} q^n h_n^*(\mathbf{c}, q) z H(-z) z q^{-1} H(-q^{-1}z) \cdots z q^{1-n} H(-q^{1-n}z) \\ &= \Phi \circ_{q^{-1}} F. \end{aligned} \quad (126)$$

On the other hand, Theorem 18 can be expressed as

$$\frac{1}{H(-z)} = \sum_{n=0}^{\infty} q^{-\binom{n}{2}} h_n^*(q) z^n H(-z/q) \cdots H(-z/q^n), \quad (127)$$

or

$$z = \sum_{n=0}^{\infty} q^{-\binom{n}{2}} h_n^*(q) z^{n+1} H(-z) H(-z/q) \cdots H(-z/q^n) \quad (128)$$

$$\begin{aligned} &= \sum_{n=0}^{\infty} q^n h_n^*(q) \{zH(-z)\} \left\{ \frac{z}{q} H(-z/q) \right\} \cdots \left\{ \frac{z}{q^n} H(-z/q^n) \right\} \\ &= G \circ_{q^{-1}} F. \end{aligned} \quad (129)$$

Thus, using Theorem 17, we have

$$\begin{aligned} \Phi &= (\Phi \circ_{q^{-1}} F) \circ_q G \\ &= \left(\sum_{k=0}^{\infty} e_k \mu_k q^k z^k \right) \circ_q G. \end{aligned} \quad (130)$$

Comparing coefficients of z^n in (130) and simplifying we see that Theorem 19 is equivalent to the statement

$$q^n h_n^*(\mathbf{c}, q) = \sum_{k=0}^n q^{\binom{k}{2}+k} e_k c_k \sum_{\substack{n_1+\dots+n_k=n-k \\ n_i \geq 0}} q^{n-k} \prod_{i=1}^k q^{(i-1)n_i} h_{n_i}^*(q). \quad (131)$$

To prove (131) we use the “factorization of Dyck paths” as discussed in [Hai94]. This can be represented pictorially as in Figure 10. The terms multiplied by c_k correspond to $\pi \in L_{n,n}^+(k)$. The area of the parallelogram region whose left border is on the line $y = x + i - 1$ is $(i - 1)n_i$, where n_i is the length of the left border of the parallelogram. Using the fact that the path to the left of this parallelogram is in L_{n_i, n_i}^+ , (131) now becomes transparent. \square

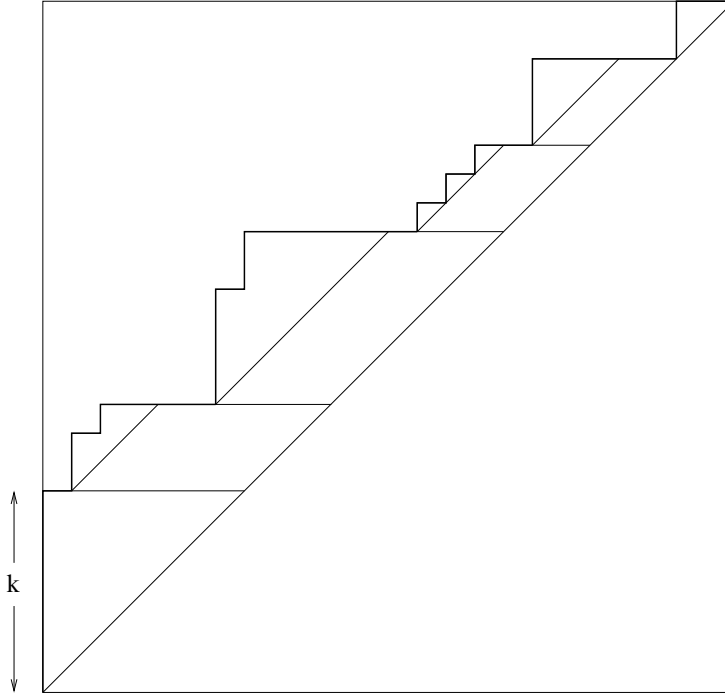

Figure 10: A Dyck path factored into smaller paths.

Letting $e_k = 1$, $c_j = \chi(j = k)$ and replacing q by q^{-1} and z by z/q in Theorem 19 we get the following.

Corollary 9 For $1 \leq k \leq n$,

$$z^k = \sum_{n \geq k} q^{\binom{n}{2}-n+k} F_{n,k}(q^{-1}, 1) z^n(z)_n. \quad (132)$$

Theorem 19 is a q -analogue of the general Lagrange inversion formula [AAR99, p.629]

$$f(x) = f(0) + \sum_{n=1}^{\infty} \frac{x^n}{n! \phi(x)^n} \left[\frac{d^{n-1}}{dx^{n-1}} (f'(x) \phi^n(x)) \right]_{x=0}, \quad (133)$$

where ϕ and f are analytic in a neighborhood of 0, with $\phi(0) \neq 0$. To see why, assume WLOG $f(0) = 1$, and set $f(x) = \sum_{k=0}^{\infty} c_k x^k$ and $\phi = \frac{1}{H(-x)} = \sum_{k=0}^{\infty} e_k x^k$ in (133) to get

$$\sum_{k=1}^{\infty} c_k x^k = \sum_{n=1}^{\infty} \frac{x^n}{n!} H(-x)^n \frac{d^{n-1}}{dx^{n-1}} \left(\sum_{k=1}^{\infty} k c_k x^{k-1} \left(\sum_{m=0}^{\infty} e_m x^m \right)^n \right) \Big|_{x=0} \quad (134)$$

$$= \sum_{n=1}^{\infty} \frac{x^n}{n!} H(-x)^n \sum_{k=1}^n k c_k (n-1)! \left(\sum_{m=0}^{\infty} e_m x^m \right)^n \Big|_{x^{n-k}} \quad (135)$$

$$= \sum_{n=1}^{\infty} x^n H(-x)^n \sum_{k=1}^n c_k \frac{k}{n} \sum_{\substack{j_1+j_2+\dots+j_n=n-k \\ j_i \geq 0}} e_{j_1} e_{j_2} \cdots e_{j_n} \quad (136)$$

$$= \sum_{n=1}^{\infty} x^n H(-x)^n \sum_{k=1}^n c_k \frac{k}{n} \sum_{\alpha \vdash n-k} e_{\alpha} \binom{n}{k - \ell(\alpha), n_1(\alpha), n_2(\alpha), \dots}. \quad (137)$$

The equivalence of (137) to the $q = 1$ case of Theorem 19 (with c_k replaced by c_k/e_k) will follow if we can show that for any fixed $\alpha \vdash n - k$,

$$\sum_{\substack{\pi \in L_{n,n}^+(k) \\ \beta(\pi) - k = \alpha}} 1 = \frac{k}{n} \binom{n}{k - \ell(\alpha), n_1(\alpha), n_2(\alpha), \dots}, \quad (138)$$

where $\beta - k$ is the partition obtained by removing one part of size k from β . See [Hag03] for an inductive proof of (138).

In [Hai94] Haiman includes a discussion of the connection of Theorem 18 to q -Lagrange inversion formulas of Andrews, Garsia, and Gessel [And75], [Gar81], [Ges80]. Further background on these formulas is contained in [Sta88]. Garsia and Haiman used q -Lagrange inversion to obtain the interesting identity

$$\nabla e_n |_{t=1} = \sum_{\pi \in L_{n,n}^+} q^{\text{area}(\pi)} e_{\beta(\pi)} \quad (139)$$

for the $t = 1$ case of the Frobenius series.

Garsia and Haiman were also able to obtain the $t = 1/q$ case of $\mathcal{F}(DH_n; q, t)$, which can be expressed as follows.

Theorem 20

$$q^{\binom{n}{2}} \mathcal{F}(DH_n; q, 1/q) = \frac{1}{[n+1]} e_n(XY), \quad (140)$$

where $Y = \{1, q, \dots, q^n\}$. Equivalently, by the Cauchy identity (50),

$$\left\langle q^{\binom{n}{2}} \mathcal{F}(DH_n; q, 1/q), s_{\lambda} \right\rangle = \frac{1}{[n+1]} s_{\lambda'}(1, q, \dots, q^n). \quad (141)$$

Note that by Theorem 7, the special case $\lambda = 1^n$ of (141) reduces to (93), the formula for MacMahon's maj-statistic q -Catalan.

Open Problem 2 Find a q, t -version of the Lagrange inversion formula which will yield an identity for $\mathcal{F}(DH_n; q, t)$, and which reduces to Theorem 19 when $t = 1$ and incorporates (140).

3 Parking Functions and the Hilbert Series

Extension of the dinv Statistic

Another beautiful corollary of Haiman’s formula for $\mathcal{F}(DH_n; q, t)$ is that the dimension of DH_n equals $(n + 1)^{n-1}$, which is the number of *parking functions* on n cars. See the chapter in this volume on parking functions for more information on these important combinatorial objects. In this chapter we will view parking functions geometrically, as a Dyck path π together with a placement of the numbers, or “cars”, 1 through n in the squares just to the right of N steps of π , with strict decrease down columns. See Figure 11.

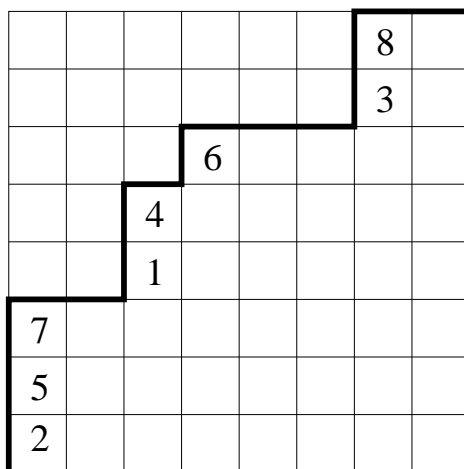

Figure 11: A parking function P .

We now describe an extension of the dinv statistic to parking functions. Let \mathcal{P}_n denote the set of all parking functions on n cars. Given $P \in \mathcal{P}_n$ with associated Dyck path $\pi = \pi(P)$, if car i is in row j we say $\text{occupant}(j) = i$. Let $\text{dinv}(P)$ be the number of pairs (i, j) , $1 \leq i < j \leq n$ such that

$$\begin{aligned} \text{dinv}(P) = & |\{(i, j) : 1 \leq i < j \leq n, \quad a_i = a_j, \text{ and } \text{occupant}(i) < \text{occupant}(j)\}| \\ & + |\{(i, j) : 1 \leq i < j \leq n, \quad a_i = a_j + 1, \text{ and } \text{occupant}(i) > \text{occupant}(j)\}|. \end{aligned}$$

Thus $\text{dinv}(P)$ is the number of pairs of rows of P of the same length, with the row above containing the larger car, or which differ by one in length, with the longer row below the shorter, and the longer row containing the larger car. For example, for the parking function in Figure 11, the inversion pairs (i, j) are $(1, 7)$, $(2, 7)$, $(2, 8)$, $(3, 4)$, $(4, 8)$ and $(5, 6)$, so $\text{dinv}(P) = 6$.

We define $\text{area}(P) = \text{area}(\pi)$, and also define the *reading word* of P , denoted $\text{read}(P)$, to be the permutation obtained by reading the cars along diagonals in a southwest direction, starting with the diagonal farthest from the line $y = x$, then working inwards. For example, the parking function in Figure 11 has area 9 and reading word 64781532.

Remark 7 Note that $\text{read}(P) = n \cdots 21$ if and only if $\text{dinv}(P) = \text{dinv}(\pi)$. We call this parking function the *Maxdinv* parking function for π , which we denote by $\text{Maxdinv}(\pi)$.

Recall that Remark 4 implies

$$\mathcal{H}(DH_n; q, t) = \langle \mathcal{F}(DH_n; q, t), h_{1^n} \rangle. \quad (142)$$

In [HL05] N. Loehr and the author advance the following Conjectured combinatorial formula for the Hilbert series, which is still open.

Conjecture 1

$$\mathcal{H}(DH_n; q, t) = \sum_{P \in \mathcal{P}_n} q^{\text{divv}(P)} t^{\text{area}(P)}. \quad (143)$$

Conjecture 1 has been verified in Maple for $n \leq 11$. The truth of the Conjecture when $q = 1$ follows easily from (139) and (142). Later in this section we will show (Corollary 11) that divv has the same distribution as area over \mathcal{P}_n , which implies the Conjecture is also true when $t = 1$.

An Explicit Formula

Given $\tau \in S_n$, with descents at places $i_1 < i_2 < \dots < i_k$, we call the first i_1 letters of τ the first run of τ , the next $i_2 - i_1$ letters of τ the second run of τ , \dots , and the last $n - i_k$ letters of τ the $(k + 1)$ st run of τ . For example, the runs of 58246137 are 58, 246 and 137. It will prove convenient to call element 0 the $k + 2$ nd run of τ . Let $\text{cars}(\tau)$ denote the set of parking functions whose cars in rows of length 0 consist of the elements of the $(k + 1)$ st run of τ (in any order), whose cars in rows of length 1 consist of the elements of the k th run of τ (in any order), \dots , and whose cars in rows of length k consist of the elements of the first run of τ (in any order). For example, the elements of $\text{cars}(31254)$ are listed in Figure 12.

Let τ be as above, and let i be a given integer satisfying $1 \leq i \leq n$. If τ_i is in the j th run of τ , we define $w_i(\tau)$ to be the number of elements in the j th run which are larger than τ_i , plus the number of elements in the $j + 1$ st run which are smaller than τ_i . For example, if $\tau = 385924617$, then the values of w_1, w_2, \dots, w_9 are 1, 1, 3, 3, 3, 2, 1, 2, 1.

Theorem 21 *Given $\tau \in S_n$,*

$$\sum_{P \in \text{cars}(\tau)} q^{\text{divv}(P)} t^{\text{area}(P)} = t^{\text{maj}(\tau)} \prod_{i=1}^n [w_i(\tau)]_q. \quad (144)$$

Proof. We will build up elements of $\text{cars}(\tau)$ by starting at the end of τ , where elements go in rows of length 0, and adding elements right to left. We define a partial parking function to be a Dyck path $\pi \in L_{m,m}^+$ for some m , together with a placement of m distinct positive integers (not necessarily the integers 1 through m) to the right of the N steps of π , with strict decrease down columns. Say $\tau = 385924617$ and we have just added car 9 to obtain a partial parking function A with cars 1 and 7 in rows of length 0, cars 2, 4 and 6 in rows of length 1, and car 9 in a row of length 2, as in the upper left grid of Figure 13. The rows with *’s to the right are rows above which we can insert a row of length 2 with car 5 in it and still have a partial parking function. Note the number of starred rows equals $w_3(\tau)$, and that in general $w_i(\tau)$ can be defined as the number of ways to insert a row containing car τ_i into a partial parking function containing cars $\tau_{i+1}, \dots, \tau_n$, in rows of the appropriate length, and still obtain a partial parking function.

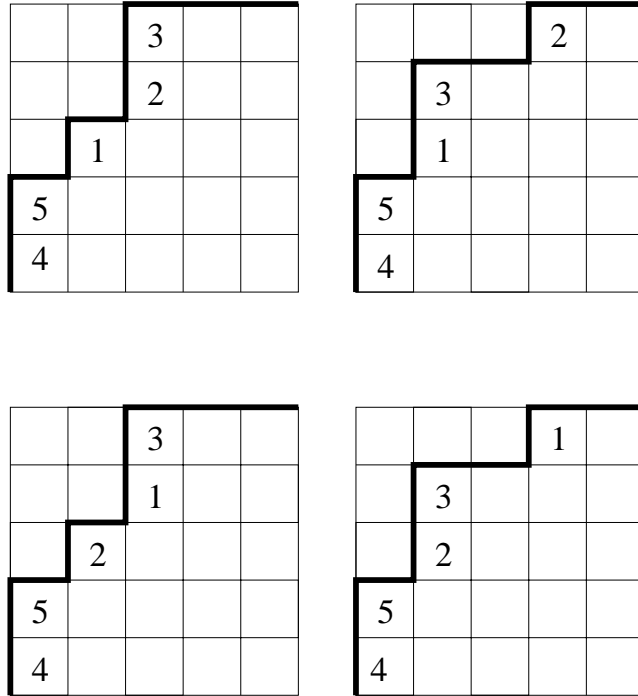

Figure 12: The elements of cars(31254).

Consider what happens to dinv as we insert the row with car 5 above a starred row to form A' . Pairs of rows which form inversions in A will also form inversions in A' . Furthermore the rows of length 0 in A , or of length 1 with a car larger than 5, cannot form inversions with car 5 no matter where it is inserted. However, a starred row will form an inversion with car 5 if and only if car 5 is in a row below it. It follows that if we weight insertions by q^{dinv} , inserting car 5 at the various places will generate a factor of $[w_i(\tau)]$ times the weight of A , as in Figure 13. Finally note that for any path π corresponding to an element of $\text{cars}(\tau)$, $\text{maj}(\tau) = \text{area}(\pi)$. \square

By summing Theorem 21 over all $\tau \in S_n$ we get the following.

Corollary 10

$$\sum_{P \in \mathcal{P}_n} q^{\text{dinv}(P)} t^{\text{area}(P)} = \sum_{\tau \in S_n} t^{\text{maj}(\tau)} \prod_{i=1}^n [w_i(\tau)]_q. \quad (145)$$

Open Problem 3 *Prove*

$$\sum_{P \in \mathcal{P}_n} q^{\text{dinv}(P)} t^{\text{area}(P)} \quad (146)$$

is symmetric in q, t .

Remark 8 *Beyond merely proving the symmetry of (146), one could hope to find a bijective proof. It is interesting to note that by (144) the symmetry in q, t when one variable equals 0 reduces to the fact that both inv and maj are Mahonian. Hence any bijective proof of symmetry may have to involve generalizing Foata's bijective transformation of maj into inv .*

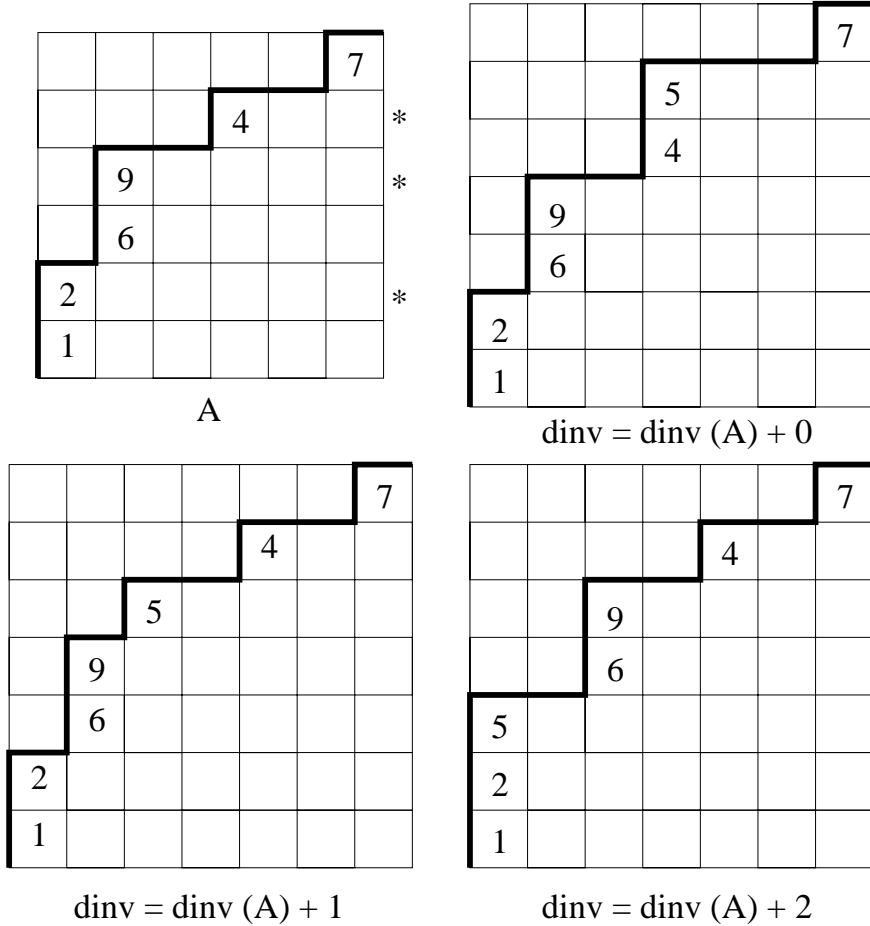

Figure 13: Partial parking functions occurring in the proof of Theorem 21.

The Statistic area'

By a *diagonal labeling* of a Dyck path $\pi \in L_{n,n}^+$ we mean a placement of the numbers 1 through n in the squares on the main diagonal $y = x$ in such a way that for every consecutive EN pair of steps of π , the number in the same column as the E step is smaller than the number in the same row as the N step. Let \mathcal{A}_n denote the set of pairs (A, π) where A is a diagonal labeling of $\pi \in L_{n,n}^+$. Given such a pair (A, π) , we let $\text{area}'(A, \pi)$ denote the number of area squares x of π for which the number on the diagonal in the same column as x is smaller than the number in the same row as x . Also define $\text{bounce}(A, \pi) = \text{bounce}(\pi)$.

The following result appears in [HL05].

Theorem 22 *There is a bijection between \mathcal{P}_n and \mathcal{A}_n which sends $(\text{dinv}, \text{area})$ to $(\text{area}', \text{bounce})$.*

Proof. Given $P \in \mathcal{P}_n$ with associated path π , we begin to construct a pair $(A, \zeta(\pi))$ by first letting $\zeta(\pi)$ be the same path formed by the ζ map from the proof of Theorem 16. The length α_1 of the first bounce of ζ is the number of rows of π of length 0, etc.. Next place the cars which occur in P in the rows of length 0 in the lowest α_1 diagonal squares of ζ , in such a way that the

order in which they occur, reading top to bottom, in P is the same as the order in which they occur, reading top to bottom, in ζ . Then place the cars which occur in P in the rows of length 1 in the next α_2 diagonal squares of ζ , in such a way that the order in which they occur, reading top to bottom, in P is the same as the order in which they occur, reading top to bottom, in ζ . Continue in this way until all the diagonal squares are filled, resulting in the pair (A, ζ) . See Figure 14 for an example.

The properties of the ζ map immediately imply $\text{area}(\pi) = \text{bounce}(A, \zeta)$ and that $(A, \zeta) \in \mathcal{A}_n$. The reader will have no trouble showing that the equation $\text{dinv}(P) = \text{area}'(A, \zeta)$ is also implicit in the proof of Theorem 16. \square

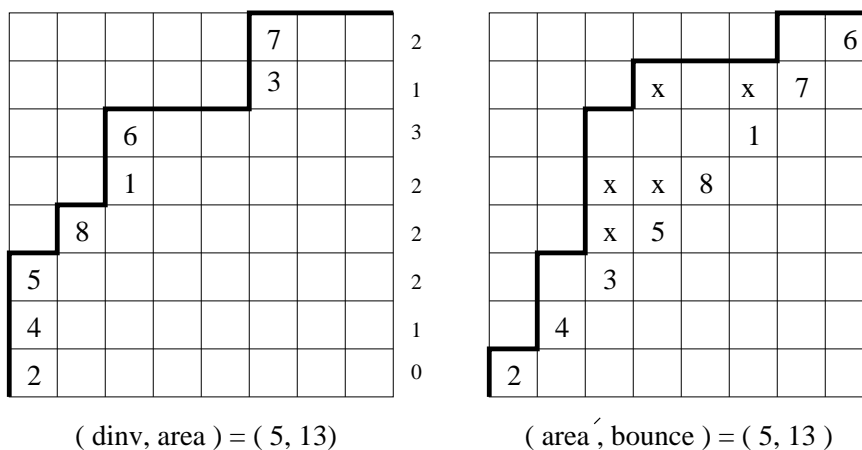

Figure 14: The map in the proof of Theorem 22. Squares contributing to area' are marked with x 's.

Remark 9 Drew Armstrong [Arm13] has found an interpretation for the area' statistic, as well as the bounce and dinv statistics, in terms of hyperplane arrangements. See also [AR12].

The pmaj Statistic

We now define a statistic on parking functions called pmaj, due to Loehr and Remmel [LR04], [Loe05a] which generalizes the bounce statistic. Given $P \in \mathcal{P}_n$, we define the pmaj-parking order, denoted $\beta(P)$, by the following procedure. Let $C_i = C_i(P)$ denote the set of cars in column i of P , and let β_1 be the largest car in C_1 . We begin by parking car β_1 in spot 1. Next we perform the “dragnet” operation, which takes all the cars in $C_1 \setminus \{\beta_1\}$ and combines them with C_2 to form C'_2 . Let β_2 be the largest car in C'_2 which is smaller than β_1 . If there is no such car, let β_2 be the largest car in C'_2 . Park car β_2 in spot 2 and then iterate this procedure. Assuming we have just parked car β_{i-1} in spot $i-1$, $3 \leq i < n$, we let $C'_i = C'_{i-1} \setminus \{\beta_{i-1}\}$ and let β_i be the largest car in C'_i which is smaller than β_{i-1} , if any, while otherwise β_i is the largest car in C'_i . For the example in Figure 15, we have $C_1 = \{5\}$, $C_2 = \{1, 7\}$, $C_3 = \{\}$, etc. and $C'_2 = \{1, 7\}$, $C'_3 = \{7\}$, $C'_4 = \{2, 4, 6\}$, $C'_5 = \{2, 3, 4\}$, etc., with $\beta = 51764328$.

Now let $\text{rev}(\beta(P)) = (\beta_n, \beta_{n-1}, \dots, \beta_1)$ and define $\text{pmaj}(P) = \text{maj}(\text{rev}(\beta(P)))$. For the parking function of Figure 15 we have $\text{rev}(\beta) = 82346715$ and $\text{pmaj} = 1 + 6 = 7$. Given $\pi \in L_{n,n}^+$, it is easy to see that if P is the parking function for π obtained by placing car i in row

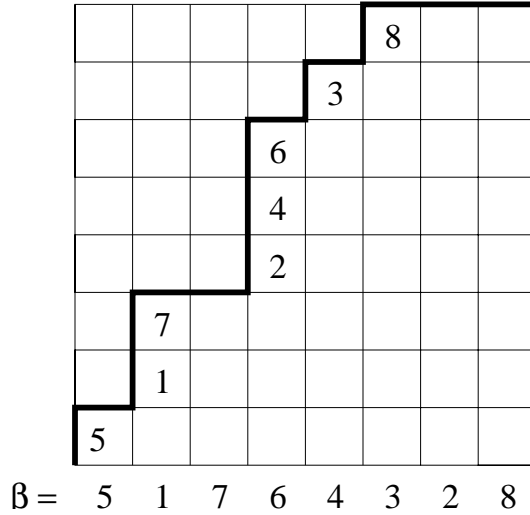

Figure 15: A parking function P with pmaj parking order $\beta = 51764328$.

i for $1 \leq i \leq n$, then $\text{pmaj}(P) = \text{bounce}(\pi)$. We call this parking function the primary pmaj parking function for π .

We now describe a bijection Γ from \mathcal{P}_n to \mathcal{P}_n from [LR04] which sends $(\text{area}, \text{pmaj}) \rightarrow (\text{divn}, \text{area})$. The crucial observation behind it is this. Fix $\gamma \in S_n$ and consider the set of parking functions which satisfy $\text{rev}(\beta(P)) = \gamma$. We can build up this set recursively by first forming a partial parking function consisting of car γ_n in column 1. If $\gamma_{n-1} < \gamma_n$, then we can form a partial parking function consisting of two cars whose pmaj parking order is $\gamma_n \gamma_{n-1}$ in two ways. We can either have both cars γ_n and γ_{n-1} in column 1, or car γ_n in column 1 and car γ_{n-1} in column 2. If $\gamma_{n-1} > \gamma_n$, then we must have car γ_n in column 1 and car γ_{n-1} in column 2. In the case where $\gamma_{n-1} < \gamma_n$, there were two choices for columns to insert car γ_{n-1} into, corresponding to the fact that $w_{n-1}(\gamma) = 2$. When $\gamma_{n-1} > \gamma_n$, there was only one choice for the column to insert γ_{n-1} into, and correspondingly $w_{n-1}(\gamma) = 1$.

More generally, say we have a partial parking function consisting of cars in the set $\{\gamma_n, \dots, \gamma_{i+1}\}$ whose pmaj parking order is $\gamma_n \cdots \gamma_{i+2} \gamma_{i+1}$. It is easy to see that the number of ways to insert car γ_i into this so the new partial parking function has pmaj parking order $\gamma_n \cdots \gamma_{i+1} \gamma_i$ is exactly $w_i(\gamma)$. Furthermore, as you insert car γ_i into columns $n - i + 1, n - i, \dots, n - i - w_i(\gamma) + 2$ the area of the partial parking function increases by 1 each time. It follows that

$$\sum_{P \in \mathcal{P}_n} q^{\text{area}(P)} t^{\text{pmaj}(P)} = \sum_{\gamma \in S_n} t^{\text{maj}(\gamma)} \prod_{i=1}^n [w_i(\gamma)]_q. \quad (147)$$

Moreover, we can identify the values of $(\text{area}, \text{pmaj})$ for individual parking functions by considering permutations $\gamma \in S_n$ and corresponding n -tuples (u_1, \dots, u_n) with $0 \leq u_i < w_i(\gamma)$ for $1 \leq i \leq n$. (Note u_n always equals 0). Then $\text{maj}(\gamma) = \text{pmaj}(P)$, and $u_1 + \dots + u_n = \text{area}(P)$. (For those familiar with the description of parking functions in terms of preference functions, we have $f(\beta_{n+1-i}) = n + 1 - i - u_i$ for $1 \leq i \leq n$.)

Now given such a pair $\gamma \in S_n$ and corresponding n -tuple (u_1, \dots, u_n) , from the proof of Theorem 21 we can build up a parking function Q recursively by inserting cars $\gamma_n, \gamma_{n-1}, \dots$

one at a time, where for each j the insertion of car γ_j adds u_j to $\text{dinv}(Q)$. Thus we end up with a bijection $\Gamma : P \mapsto Q$ with $(\text{area}(P), \text{pmaj}(P)) = (\text{dinv}(Q), \text{area}(Q))$. The top of Figure 16 gives the various partial parking functions in the construction of P , and after those are the various partial parking functions in the construction of Q , for $\gamma = 563412$ and $(u_1, \dots, u_6) = (2, 0, 1, 0, 1, 0)$.

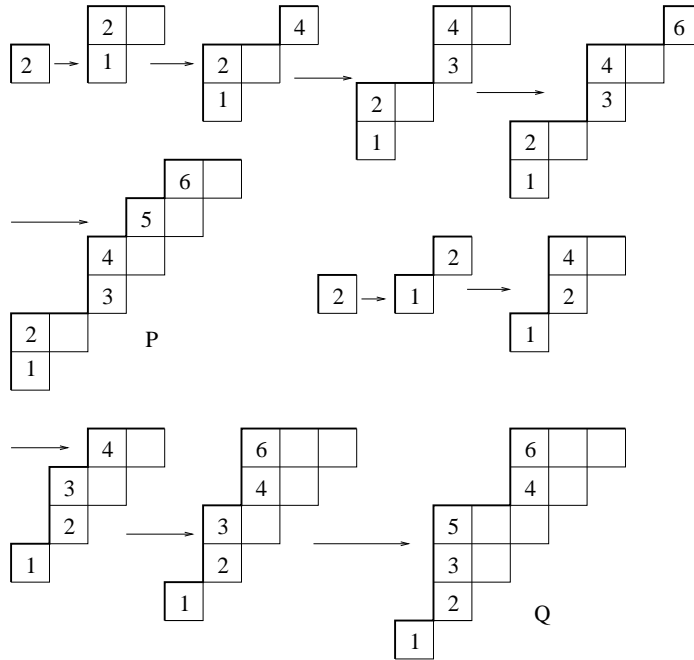

Figure 16: The recursive construction of the P and Q parking functions in the Γ correspondence for $\gamma = 563412$ and $u = (2, 0, 1, 0, 1, 0)$.

Corollary 11 *The marginal distributions of pmaj , area , and dinv over \mathcal{P}_n are all the same, i.e.*

$$\sum_{P \in \mathcal{P}_n} q^{\text{pmaj}(P)} = \sum_{P \in \mathcal{P}_n} q^{\text{area}(P)} = \sum_{P \in \mathcal{P}_n} q^{\text{dinv}(P)}. \quad (148)$$

Exercise 8 *Notice that in Figure 16, the final correspondence is between parking functions which equal the primary pmaj and Maxdinv parking functions for their respective paths. Show that this is true in general, i.e. that when P equals the primary pmaj parking function for π then the bijection Γ reduces to the inverse of the bijection ζ from the proof of Theorem 16.*

The Cyclic-Shift Operation

Given $S \subseteq \{1, \dots, n\}$, let $\mathcal{P}_{n,S}$ denote the set of parking functions for which $C_1(P) = S$. If $x \in \{1, 2, \dots, n\}$, define

$$\text{CYC}_n(x) = \begin{cases} x + 1 & \text{if } x < n \\ 1 & \text{if } x = n. \end{cases} \quad (149)$$

For any set $S \subseteq \{1, 2, \dots, n\}$, let $CYC_n(S) = \{CYC_n(x) : x \in S\}$. Assume $S = \{s_1 < s_2 < \dots < s_k\}$ with $s_k < n$. Given $P \in \mathcal{P}_{n,S}$, define the cyclic-shift of P , denoted $CYC_n(P)$, to be the parking function obtained by replacing C_i , the cars in column i of P , with $CYC_n(C_i)$, for each $1 \leq i \leq n$. Note that the column of P containing car n will have to be sorted, with car 1 moved to the bottom of the column. The map $CYC_n(P)$ is undefined if car n is in column 1. See the top portion of Figure 17 for an example.

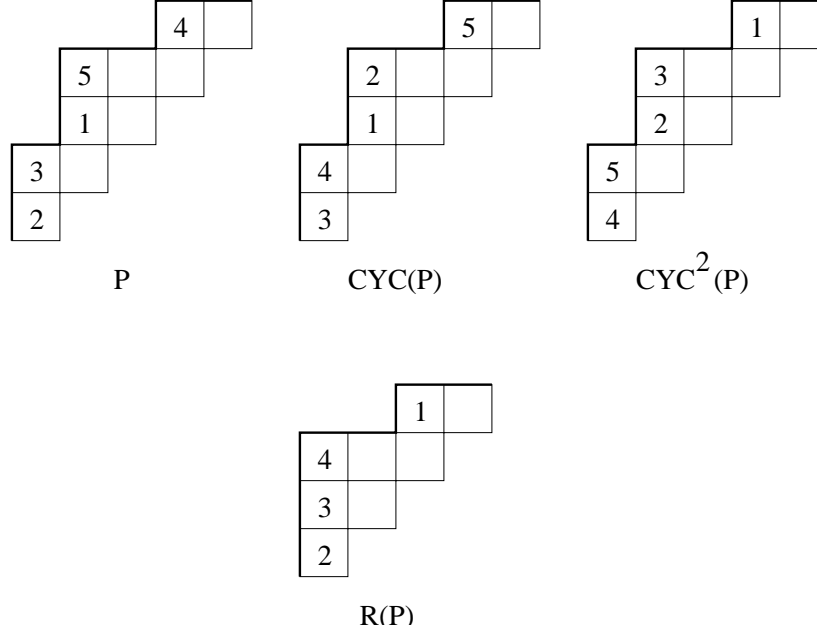

Figure 17: The map $R(P)$.

Proposition 4 [Loe05a] Suppose $P \in \mathcal{P}_{n,S}$ with $S = \{s_1 < s_2 < \dots < s_k\}$, $s_k < n$. Then

$$pmaj(P) = pmaj(CYC(P)) + 1. \quad (150)$$

Proof. Imagine adding a second coordinate to each car, with car i initially represented by (i, i) . If we list the second coordinates of each car as they occur in the pmaj parking order for P , by definition we get the sequence $\beta_1(P)\beta_2(P) \cdots \beta_n(P)$. We now perform the cyclic-shift operation to obtain $CYC(P)$, but when doing so we operate only on the first coordinates of each car, leaving the second coordinates unchanged. The reader will have no trouble verifying that if we now list the second coordinates of each car as they occur in the pmaj parking order for $CYC(P)$, we again get the sequence $\beta_1(P)\beta_2(P) \cdots \beta_n(P)$. It follows that the pmaj parking order of $CYC(P)$ can be obtained by starting with the pmaj parking order β of P and performing the cyclic-shift operation on each element of β individually. See Figure 18.

Say n occurs in the permutation $\text{rev}(\beta(P))$ in spot j . Note that we must have $j < n$, or otherwise car n would be in column 1 of P . Clearly when we perform the cyclic-shift operation on the individual elements of the permutation $\text{rev}(\beta(P))$ the descent set will remain the same, except that the descent at j is now replaced by a descent at $j - 1$ if $j > 1$, or is removed if $j = 1$. In any case the value of the major index of $\text{rev}(\beta(P))$ is decreased by 1. \square

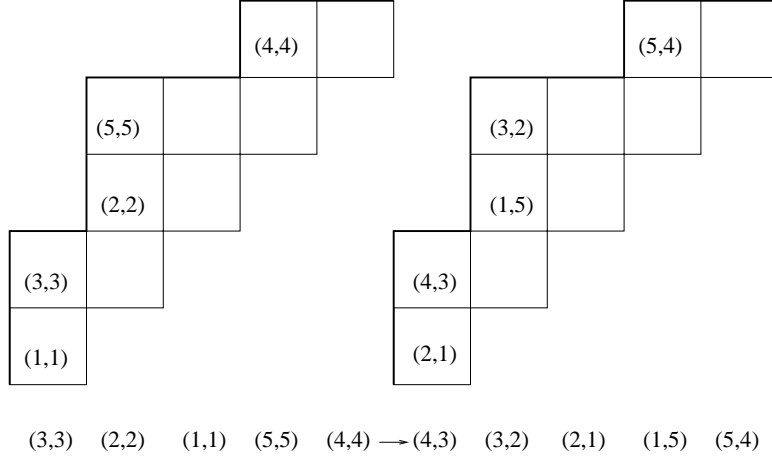

Figure 18: The cyclic-shift operation and the pmaj parking order.

Using Proposition 4, Loehr derives the following recurrence.

Theorem 23 Let $n \geq 1$ and $S = \{s_1 < \dots < s_k\} \subseteq \{1, \dots, n\}$. Set

$$P_{n,S}(q, t) = \sum_{P \in \mathcal{P}_{n,S}} q^{\text{area}(P)} t^{\text{pmaj}(P)}. \quad (151)$$

Then

$$P_{n,S}(q, t) = q^{k-1} t^{n-s_k} \sum_{T \subseteq \{1, \dots, n\} \setminus S} P_{n-1, CYC_n^{n-s_k}(S \cup T \setminus \{s_k\})}(q, t), \quad (152)$$

with the initial conditions $P_{n,\emptyset}(q, t) = 0$ for all n and $P_{1,\{1\}}(q, t) = 1$.

Proof. For $P \in \mathcal{P}_{n,S}$, let $Q = CYC_n^{n-s_k}(P)$. Then

$$\begin{aligned} \text{pmaj}(Q) + n - s_k &= \text{pmaj}(P) \\ \text{area}(Q) &= \text{area}(P). \end{aligned} \quad (153)$$

Since car n is in the first column of Q , in the pmaj parking order for Q car n is in spot 1. By definition, the dragnet operation will then combine the remaining cars in column 1 of Q with the cars in column 2 of Q . Now car n being in spot 1 translates into car n being at the end of $\text{rev}(\beta(Q))$, which means $n - 1$ is not in the descent set of $\text{rev}(\beta(Q))$. Thus if we define $R(P)$ to be the element of \mathcal{P}_{n-1} obtained by parking car n in spot 1, performing the dragnet, then truncating column 1 and spot 1 as in Figure 17, we have

$$\text{pmaj}(R(P)) = \text{pmaj}(P) - (n - s_k). \quad (154)$$

Furthermore, performing the dragnet leaves the number of area cells in columns $2, 3, \dots, n$ of Q unchanged but eliminates the $k - 1$ area cells in column 1 of Q . Thus

$$\text{area}(R(P)) = \text{area}(P) - k + 1 \quad (155)$$

and the recursion now follows easily. \square

Loehr also derives the following compact formula for $P_{n,S}$ when $t = 1/q$.

Theorem 24 For $n \geq 0$ and $S = \{s_1 < \dots < s_k\} \subseteq \{1, \dots, n\}$,

$$q^{\binom{n}{2}} P_{n,S}(1/q, q) = q^{n-k} [n]^{n-k-1} \sum_{x \in S} q^{n-x}. \quad (156)$$

Proof. Our proof is, for the most part, taken from [Loe05a]. If $k = n$,

$$P_{n,S}(1/q, q) = P_{n,\{1,\dots,n\}}(1/q, q) = q^{-\binom{n}{2}}, \quad (157)$$

while the right-hand-side of (156) equals $[n]^{-1}[n] = 1$. Thus (156) holds for $k = n$. It also holds trivially for $n = 0$ and $n = 1$. So assume $n > 1$ and $0 < k < n$. From (152),

$$\begin{aligned} P_{n,S}(1/q, q) &= q^{n+1-s_k-k} \sum_{T \subseteq \{1,\dots,n\} \setminus S} P_{n-1, CYC_n^{n-s_k}(S \cup T \setminus \{s_k\})}(1/q, q) \\ &= q^{n+1-s_k-k} \sum_{j=0}^{n-k} \sum_{\substack{T \subseteq \{1,\dots,n\} \setminus S \\ |T|=j}} P_{n-1, CYC_n^{n-s_k}(S \cup T \setminus \{s_k\})}(1/q, q). \end{aligned} \quad (158)$$

The summand when $j = n - k$ equals

$$P_{n-1, \{1,\dots,n-1\}}(1/q, q) = q^{-\binom{n-1}{2}}. \quad (159)$$

For $0 \leq j < n - k$, by induction the summand equals

$$q^{n-1-(j+k-1)-\binom{n-1}{2}} [n-1]^{n-1-(j+k-1)-1} \sum_{x \in CYC_n^{n-s_k}(S \cup T \setminus \{s_k\})} q^{n-1-x}, \quad (160)$$

since $j + k - 1 = |CYC_n^{n-s_k}(S \cup T \setminus \{s_k\})|$. Plugging (160) into (158) and reversing summation we now have

$$\begin{aligned} q^{-2n+s_k+k} q^{\binom{n}{2}} P_{n,S}(1/q, q) &= 1 + \sum_{j=0}^{n-k-1} q^{n-k-j} [n-1]^{n-k-j-1} \sum_{x=1}^{n-1} q^{n-1-x} \\ &\quad \times \sum_T \chi(T \subseteq \{1, \dots, n\} \setminus S, |T| = j, CYC_n^{s_k-n}(x) \in S \cup T \setminus \{s_k\}). \end{aligned} \quad (161)$$

To compute the inner sum over T above, we consider two cases.

1. $x = n - (s_k - s_i)$ for some $i \leq k$. Since $x < n$, this implies $i < k$, and since $CYC_n^{s_k-n}(x) = s_i$, we have $CYC_n^{s_k-n}(x) \in S \cup T \setminus \{s_k\}$. Thus the inner sum above equals the number of j -element subsets of $\{1, \dots, n\} \setminus S$, or $\binom{n-k}{j}$.
2. $x \neq n - (s_k - s_i)$ for all $i \leq k$. By Exercise 9 below, the inner sum over T in (161) equals $\binom{n-k-1}{j-1}$.

Applying the above analysis to (161) we now have

$$\begin{aligned}
q^{-2n+s_k+k} q^{\binom{n}{2}} P_{n,S}(1/q, q) &= 1 + \sum_{j=0}^{n-k-1} q^{n-k-j} [n-1]^{n-k-j-1} \\
&\times \sum_{x \text{ satisfies (1)}} \left[\binom{n-k-1}{j} + \binom{n-k-1}{j-1} \right] q^{n-1-x} \\
&+ \sum_{j=0}^{n-k-1} q^{n-k-j} [n-1]^{n-k-j-1} \sum_{x \text{ satisfies (2)}} \binom{n-k-1}{j-1} q^{n-1-x}.
\end{aligned} \tag{162}$$

Now x satisfies (1) if and only if $n-1-x = s_k - s_i - 1$ for some $i < k$, and so

$$\begin{aligned}
q^{-2n+s_k+k} q^{\binom{n}{2}} P_{n,S}(1/q, q) &= 1 + \sum_{j=0}^{n-k-1} q^{n-k-j} [n-1]^{n-k-j} \binom{n-k-1}{j-1} \\
&+ \sum_{j=0}^{n-k-1} q^{n-k-j-1} [n-1]^{n-k-j-1} \binom{n-k-1}{j} \sum_{i=1}^{k-1} q^{s_k-s_i} \\
&= \sum_{m=0}^{n-k-1} \binom{n-k-1}{m} (q[n-1])^{n-k-m-1} \\
&+ \sum_{i=1}^{k-1} q^{s_k-s_i} \sum_{j=0}^{n-k-1} (q[n-1])^{n-k-j-1} \binom{n-k-1}{j} \\
&= (1 + q[n-1])^{n-k-1} + \sum_{i=1}^{k-1} q^{s_k-s_i} (1 + q[n-1])^{n-k-1} \\
&= [n]^{n-k-1} (1 + \sum_{i=1}^{k-1} q^{s_k-s_i}).
\end{aligned} \tag{163}$$

Thus

$$q^{\binom{n}{2}} P_{n,S}(1/q, q) = q^{n-k} [n]^{n-k-1} \sum_{x \in S} q^{s_k-x+n-s_k}. \tag{164}$$

□

Exercise 9 Show that if $x \neq n - (s_k - s_i)$ for all $i \leq k$, the inner sum over T in (161) equals $\binom{n-k-1}{j-1}$.

As a corollary of his formula for $\mathcal{F}(DH_n; q, t)$, Haiman proves a Conjecture he attributes in [Hai94] to Stanley, namely that

$$q^{\binom{n}{2}} \mathcal{H}(DH_n; 1/q, q) = [n+1]^{n-1}. \tag{165}$$

Theorem 24 and (165) together imply Conjecture 1 is true when $t = q$ and $q = 1/q$. To see why, first observe that

$$P_{n+1, \{n+1\}}(q, t) = \sum_{P \in \mathcal{P}_n} q^{\text{area}(P)} t^{\text{pmaj}(P)}. \tag{166}$$

Hence by Theorem 24,

$$\begin{aligned}
q^{\binom{n}{2}} \sum_{P \in \mathcal{P}_n} q^{-\text{area}(P)} q^{\text{pmaj}(P)} &= q^{\binom{n}{2}} P_{n+1, \{n+1\}}(1/q, q) \\
&= q^{-n} q^{\binom{n+1}{2}} P_{n+1, \{n+1\}}(1/q, q) \\
&= q^{-n} q^n [n+1]^{n-1} q^0 = [n+1]^{n-1}.
\end{aligned} \tag{167}$$

The main impediment to proving Conjecture 1 seems to be the lack of a recursive decomposition of the Hilbert series along the lines of (87).

Tesler Matrices

For an $n \times n$ upper triangular matrix, we define the j th hook sum, where $1 \leq j \leq n$, to be the sum of all the entries in the j th row of the matrix, minus the sum of all the entries in the j th column strictly above the diagonal. A *Tesler matrix* of order n is an $n \times n$ upper-triangular matrix of nonnegative integers, such that all the hook sums equal 1. Let $\text{Tes}(n)$ denote the set of Tesler matrices of order n . For example, the elements of $\text{Tes}(3)$ are

$$\begin{aligned}
&\begin{bmatrix} 1 & 0 & 0 \\ 0 & 1 & 0 \\ 0 & 0 & 1 \end{bmatrix}, \begin{bmatrix} 1 & 0 & 0 \\ 0 & 0 & 1 \\ 0 & 0 & 2 \end{bmatrix}, \begin{bmatrix} 0 & 1 & 0 \\ 0 & 2 & 0 \\ 0 & 0 & 1 \end{bmatrix}, \begin{bmatrix} 0 & 1 & 0 \\ 0 & 1 & 1 \\ 0 & 0 & 2 \end{bmatrix}, \\
&\begin{bmatrix} 0 & 1 & 0 \\ 0 & 0 & 2 \\ 0 & 0 & 3 \end{bmatrix}, \begin{bmatrix} 0 & 0 & 1 \\ 0 & 1 & 0 \\ 0 & 0 & 2 \end{bmatrix}, \begin{bmatrix} 0 & 0 & 1 \\ 0 & 0 & 1 \\ 0 & 0 & 3 \end{bmatrix}.
\end{aligned} \tag{168}$$

Let $[k]_{q,t} = (t^k - q^k)/(t - q)$ denote the q, t -analog of the integer k , and recall that $M = (1 - q)(1 - t)$. To each Tesler matrix C we associate the weight

$$\text{wt}(C) = (-M)^{\text{pos}(C)-n} \prod_{c_{ij} > 0} [c_{ij}]_{q,t},$$

where $\text{pos}(C)$ is the number of positive entries in C . For example, the weight of

$$\begin{bmatrix} 0 & 1 & 0 \\ 0 & 1 & 1 \\ 0 & 0 & 2 \end{bmatrix}$$

is $(t + q)(-M) = -(t + q)(1 - q)(1 - t)$.

Using the theory of Macdonald polynomials and (79), Haglund [Hag11] proved the following result, which gives a formula for $\mathcal{H}(DH_n; q, t)$ in terms of Tesler matrices.

Theorem 25 [Hag11]

$$\mathcal{H}(DH_n; q, t) = \sum_{C \in \text{Tes}(n)} \text{wt}(C). \tag{169}$$

Example 3 When $n = 3$, the terms in (168), with weights, give

$$\begin{aligned} \mathcal{H}(DH_3; q, t) = & 1 + (t + q) + (t + q) - (1 - q)(1 - t)(t + q) + \\ & (t + q)(t^2 + tq + q^2) + (t + q) + (t^2 + tq + q^2). \end{aligned} \quad (170)$$

Note that Formula (169) is clearly a polynomial, and clearly symmetric in q, t . It gives a possible way of attacking Conjecture 1 without the use of symmetric function theory, since in principle one could figure out how to cancel the negative terms in the right-hand-side of (169), leaving a positive expression as in Conjecture 1. P. Levande [Lev11], [Lev12] has shown how to do this cancellation when $t = 1$ and when $t = 0$.

4 The q, t -Schröder Polynomial

The Schröder Bounce and Area Statistics

In this section we develop the theory of the q, t -Schröder polynomial, which gives a combinatorial interpretation, in terms of statistics on Schröder lattice paths, for the coefficient of a Schur hook shape in $\mathcal{F}(DH_n; q, t)$. A *Schröder path* is a lattice path from $(0, 0)$ to (n, n) consisting of $N(0, 1)$, $E(1, 0)$ and diagonal $D(1, 1)$ steps which never goes below the line $y = x$. We let $L_{n,n,d}^+$ denote the set of Schröder lattice paths consisting of $n - d$ N steps, $n - d$ E steps, and d D steps. We refer to a triangle whose vertex set is of the form $\{(i, j), (i + 1, j), (i + 1, j + 1)\}$ for some (i, j) as a “lower triangle”, and define the area of a Schröder path π to be the number of lower triangles below π and above the line $y = x$. Note that if π has no D steps, then the Schröder definition of area agrees with the definition of the area of a Catalan path. We let $a_i(\pi)$ denote the length of the i th row, i.e., the number of lower triangles between the path and the diagonal in the i th row from the bottom of π , so $\text{area}(\pi) = \sum_{i=1}^n a_i(\pi)$.

Given $\pi \in L_{n,n,d}^+$, let $\sigma(\pi)$ be the word of 0’s, 1’s and 2’s obtained in the following way. Initialize σ to be the empty string, then start at $(0, 0)$ and travel along π to (n, n) , adding a 0, 1, or 2 to the end of $\sigma(\pi)$ when we encounter a N , D , or E step, respectively, of π . (If π is a Dyck path, then this definition of $\sigma(\pi)$ is the same as the previous definition from Section 1, except that we end up with a word of 0’s and 2’s instead of 0’s and 1’s. Since all our applications involving $\sigma(\pi)$ depend only on the relative order of the elements of $\sigma(\pi)$, this change is only a superficial one.) We define the statistic $\text{bounce}(\pi)$ by means of the following algorithm.

Algorithm 2 1. First remove all D steps from π , and collapse to obtain a Catalan path $\Gamma(\pi)$. More precisely, let $\Gamma(\pi)$ be the Catalan path for which $\sigma(\Gamma(\pi))$ equals $\sigma(\pi)$ with all 1’s removed. Recall the i th peak of $\Gamma(\pi)$ is the lattice point where the bounce path for $\Gamma(\pi)$ switches direction from N to E for the i th time. The lattice point at the beginning of the corresponding E step of π is called the i th peak of π .

2. For each D step x of π , let $\text{nump}(x)$ be the number of peaks of π below x . Then define

$$\text{bounce}(\pi) = \text{bounce}(\Gamma(\pi)) + \sum_x \text{nump}(x), \quad (171)$$

where the sum is over all D steps of π . For example, if π is the Schröder path on the left in Figure 19, with $\Gamma(\pi)$ on the right, then $\text{bounce}(\pi) = (3 + 1) + (0 + 1 + 1 + 2) = 8$. Note that if π has no D steps, this definition of $\text{bounce}(\pi)$ agrees with the previous definition from Section 2.

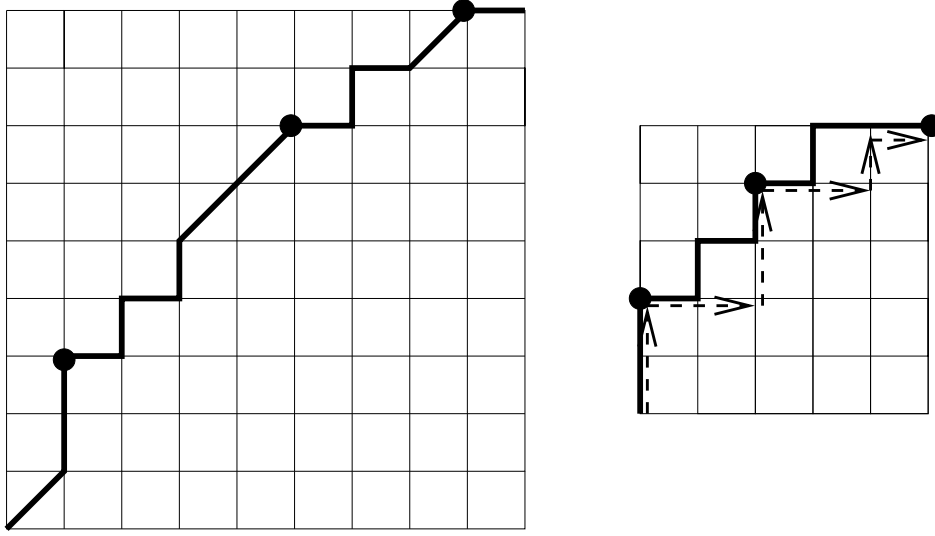

Figure 19: On the left, a Schröder path π with the peaks marked by large dots. On the right is $\Gamma(\pi)$ and its bounce path and peaks.

We call the vector whose i th coordinate is the length of the i th bounce step of $\Gamma(\pi)$ the *bounce vector* of π . Say $\Gamma(\pi)$ has b bounce steps, and call the set of rows of π between peaks i and $i + 1$ *section i* of π for $1 \leq i < b$. In addition we call section 0 the set of rows below peak 1, and section b the set of rows above peak b . If π has β_i D steps in section i , $0 \leq i \leq b$, we refer to $(\beta_0, \beta_1, \dots, \beta_b)$ as the *shift vector* of π .

For example, the path on the left in Figure 19 has bounce vector $(2, 2, 1)$ and shift vector $(1, 2, 1, 0)$. We refer to the portion of $\sigma(\pi)$ corresponding to the i th section of π as the i th section of $\sigma(\pi)$.

Given $n, d \in \mathbb{N}$, we define the q, t -Schröder polynomial $S_{n,d}(q, t)$ as follows.

$$S_{n,d}(q, t) = \sum_{\pi \in L_{n,n,d}^+} q^{\text{area}(\pi)} t^{\text{bounce}(\pi)}. \quad (172)$$

These polynomials were introduced by Egge, Haglund, Killpatrick and Kremer [EHKK03]. They Conjectured the following result, which was subsequently proved by Haglund using plethystic results involving Macdonald polynomials [Hag04].

Theorem 26 For all $0 \leq d \leq n$,

$$S_{n,d}(q, t) = \langle \mathcal{F}(DH_n; q, t), e_{n-d} h_d \rangle. \quad (173)$$

Since

$$S_{n,0}(q, t) = F_n(q, t) = C_n(q, t), \quad (174)$$

the $d = 0$ case of Theorem 26 reduces to Theorem 12.

Let $\tilde{L}_{n,n,d}^+$ denote the set of paths π which are in $L_{n,n,d}^+$ and also have no D step above the highest N step, i.e. no 1's in $\sigma(\pi)$ after the rightmost 0. Define

$$\tilde{S}_{n,d}(q, t) = \sum_{\pi \in \tilde{L}_{n,n,d}^+} q^{\text{area}(\pi)} t^{\text{bounce}(\pi)}. \quad (175)$$

Then we have

Theorem 27 *Theorem 26 is equivalent to the statement that for all $0 \leq d \leq n-1$,*

$$\tilde{S}_{n,d}(q, t) = \langle \mathcal{F}(DH_n; q, t), s_{d+1, 1^{n-d-1}} \rangle. \quad (176)$$

Proof. Given $\pi \in \tilde{L}_{n,n,d}^+$, we can map π to a path $\alpha(\pi) \in L_{n,n,d+1}^+$ by replacing the highest N step and the following E step of π by a D step. By Exercise 10 below, this map leaves area and bounce unchanged. Conversely, if $\alpha \in L_{n,n,d}^+$ has a D step above the highest N step, we can map it to a path $\pi \in \tilde{L}_{n,n,d-1}^+$ in an area and bounce preserving fashion by changing the highest D step to a NE pair. It follows that for $1 \leq d \leq n$,

$$\begin{aligned} S_{n,d}(q, t) &= \sum_{\pi \in \tilde{L}_{n,n,d}^+} q^{\text{area}(\pi)} t^{\text{bounce}(\pi)} + \sum_{\pi \in \tilde{L}_{n,n,d-1}^+} q^{\text{area}(\pi)} t^{\text{bounce}(\pi)} \\ &= \tilde{S}_{n,d}(q, t) + \tilde{S}_{n,d-1}(q, t). \end{aligned} \quad (177)$$

Since $S_{n,0}(q, t) = \tilde{S}_{n,0}(q, t)$, $e_{n-d}h_d = s_{d+1, 1^{n-d-1}} + s_{d, 1^{n-d}}$ for $0 < d \leq n-1$, and $S_{n,n}(q, t) = 1 = \tilde{S}_{n,n-1}(q, t)$, the result follows by a simple inductive argument. \square

Exercise 10 *Given π and $\alpha(\pi)$ in the proof of Theorem 27, show that*

$$\text{area}(\pi) = \text{area}(\alpha(\pi)) \quad (178)$$

$$\text{bounce}(\pi) = \text{bounce}(\alpha(\pi)). \quad (179)$$

Define q, t -analogues of the big Schröder numbers r_n and little Schröder numbers \tilde{r}_n as follows.

$$r_n(q, t) = \sum_{d=0}^n S_{n,d}(q, t) \quad (180)$$

$$\tilde{r}_n(q, t) = \sum_{d=0}^{n-1} \tilde{S}_{n,d}(q, t). \quad (181)$$

The numbers $r_n(1, 1)$ count the total number of Schröder paths from $(0, 0)$ to (n, n) . The $\tilde{r}_n(1, 1)$ are known to count many different objects [Sta99, p.178], including the number of Schröder paths from $(0, 0)$ to (n, n) which have no D steps on the line $y = x$. From our comments above we have the simple identity $r_n(q, t) = 2\tilde{r}_n(q, t)$, and using Haiman's formula for $\mathcal{F}(DH_n; q, t)$ we get the polynomial identities

$$\sum_{d=0}^n w^d S_{n,d}(q, t) = \sum_{\mu \vdash n} \frac{T_\mu \prod_{x \in \mu} (w + q^{a'} t^{l'}) M \Pi_\mu B_\mu}{w_\mu} \quad (182)$$

$$\sum_{d=0}^{n-1} w^d \tilde{S}_{n,d}(q, t) = \sum_{\mu \vdash n} \frac{T_\mu \prod_{x \in \mu, x \neq (0,0)} (w + q^{a'} t^{l'}) M \Pi_\mu B_\mu}{w_\mu}. \quad (183)$$

An interesting special case of (183) is

$$\tilde{r}_{n,d}(q, t) = \sum_{\mu \vdash n} \frac{T_\mu \prod_{x \in \mu} (1 - q^{2a'} t^{2l'}) MB_\mu}{w_\mu}. \quad (184)$$

Recurrences and Explicit Formulae

We begin with a useful lemma about area and Schröder paths.

Lemma 1 (The “boundary lemma”). *Given $a, b, c \in \mathbb{N}$, let $\text{boundary}(a, b, c)$ be the path whose σ word is $2^c 1^b 0^a$. Then*

$$\sum_{\pi} q^{\text{area}'(\pi)} = \left[\begin{array}{c} a + b + c \\ a, b, c \end{array} \right]_q, \quad (185)$$

where the sum is over all paths π from $(0, 0)$ to $(c + b, a + b)$ consisting of a N steps, b D steps and c E steps, and $\text{area}'(\pi)$ is the number of lower triangles between π and $\text{boundary}(a, b, c)$.

Proof. Given π as above, we claim the number of coinversions of $\sigma(\pi)$ equals $\text{area}'(\pi)$. To see why, start with π as in Figure 20, and note that when consecutive ND , DE , or NE steps are interchanged, area' decreases by 1. Thus $\text{area}'(\pi)$ equals the number of such interchanges needed to transform π into $\text{boundary}(a, b, c)$, or equivalently to transform $\sigma(\pi)$ into $2^c 1^b 0^a$. But this is just $\text{coinv}(\sigma(\pi))$. Thus

$$\begin{aligned} \sum_{\pi} q^{\text{area}'(\pi)} &= \sum_{\sigma \in M_{(a,b,c)}} q^{\text{coinv}(\sigma)} \\ &= \sum_{\sigma \in M_{(a,b,c)}} q^{\text{inv}(\sigma)} \\ &= \left[\begin{array}{c} a + b + c \\ a, b, c \end{array} \right]_q \end{aligned} \quad (186)$$

by (9). □

Given $n, d, k \in \mathbb{N}$ with $1 \leq k \leq n$, let $L_{n,n,d}^+(k)$ denote the set of paths in $L_{n,n,d}^+$ which have k total D plus N steps below the lowest E step. We view $L_{n,n,n}^+(k)$ as containing the path with n D steps if $k = n$ and $L_{n,n,n}^+(k)$ as being the empty set if $k < n$. Define

$$S_{n,d,k}(q, t) = \sum_{\pi \in L_{n,n,d}^+(k)} q^{\text{area}(\pi)} t^{\text{bounce}(\pi)}, \quad (187)$$

with $S_{n,n,k}(q, t) = \chi(k = n)$. There is a recursive structure underlying the $S_{n,d,k}(q, t)$ which extends that underlying the $F_{n,k}(q, t)$. The following result is derived in [Hag04], and is similar to recurrence relations occurring in [EHKK03]. For any two integers n, k we use the notation

$$\delta_{n,k} = \chi(n = k). \quad (188)$$

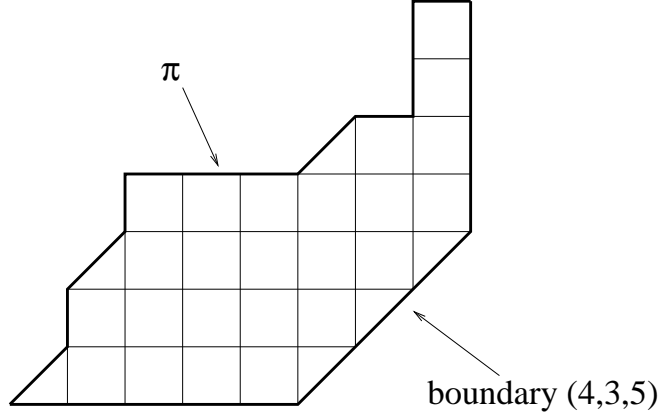

Figure 20: The region between a path π and the corresponding boundary path. For this region $\text{area}' = 27$.

Theorem 28 *Let $n, k, d \in \mathbb{N}$ with $1 \leq k \leq n$. Then*

$$S_{n,n,k}(q, t) = \delta_{n,k}, \quad (189)$$

and for $0 \leq d < n$,

$$S_{n,d,k}(q, t) = t^{n-k} \sum_{p=\max(1,k-d)}^{\min(k,n-d)} \begin{bmatrix} k \\ p \end{bmatrix}_q q^{\binom{p}{2}} \sum_{j=0}^{n-k} \begin{bmatrix} p+j-1 \\ j \end{bmatrix}_q S_{n-k,d+p-k,j}(q, t), \quad (190)$$

with the initial conditions

$$S_{0,0,k} = \delta_{k,0}, \quad S_{n,d,0} = \delta_{n,0} \delta_{d,0}. \quad (191)$$

Proof. If $d = n$ then (189) follows directly from the definition. If $d < n$ then π has at least one peak. Say π has p N steps and $k - p$ D steps in section 0. First assume $p < n - d$, i.e. Π has at least two peaks. We now describe an operation we call truncation, which takes $\pi \in L_{n,n,d}^+(k)$ and maps it to a $\pi' \in L_{n-k,n-k,d-k+p}^+$ with one less peak. Given such a π , to create π' start with $\sigma(\pi)$ and remove the first k letters (section 0). Also remove all the 2's in section 1. The result is $\sigma(\pi')$. For the path on the left in Figure 19, $\sigma(\pi) = 10020201120212$, $k = 3$ and $\sigma(\pi') = 001120212$.

We will use Figure 21 as a visual aid in the remainder of our argument. Let j be the total number of diagonal and north steps of π in section 1 of π . By construction the bounce path for $\Gamma(\pi')$ will be identical to the bounce path for $\Gamma(\Pi)$ except the first bounce of $\Gamma(\pi)$ is truncated. This bounce step hits the diagonal at (p, p) , and so the contribution to $\text{bounce}(\pi')$ from the bounce path will be $n - d - p$ less than to $\text{bounce}(\pi)$. Furthermore, for each D step of π above peak 1 of Π , the number of peaks of π' below it will be one less than the number of peaks of π below it. It follows that

$$\begin{aligned} \text{bounce}(\pi) &= \text{bounce}(\pi') + n - d - p + d - (k - p) \\ &= \text{bounce}(\pi') + n - k. \end{aligned}$$

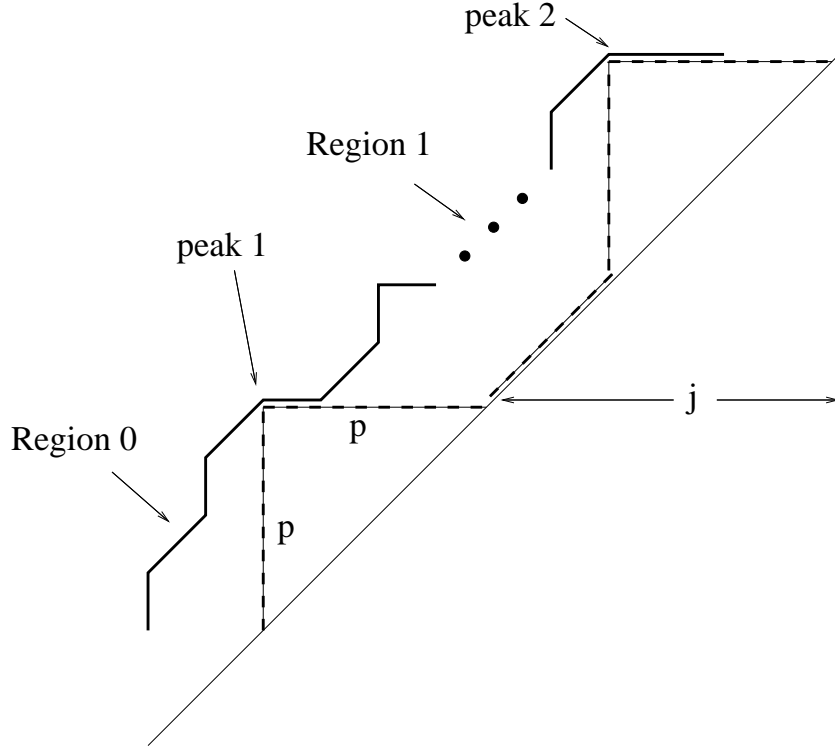

Figure 21: A path π decomposed into various regions under truncation.

Since the area below the triangle of side p from Figure 21 is $\binom{p}{2}$,

$$\text{area}(\pi) = \text{area}(\pi') + \binom{p}{2} + \text{area0} + \text{area1}, \quad (192)$$

where area0 is the area of section 0 of π , and area1 is the portion of the area of section 1 of π not included in $\text{area}(\pi')$. When we sum $q^{\text{area0}(\pi)}$ over all $\pi \in L_{n,n,d}^+(k)$ which get mapped to π' under truncation, we generate a factor of

$$\begin{bmatrix} k \\ p \end{bmatrix}_q \quad (193)$$

by the $c = 0$ case of the boundary lemma.

From the proof of the boundary lemma, area1 equals the number of coinversions of the 1st section of $\sigma(\pi)$ involving pairs of 0's and 2's or pairs of 1's and 2's. We need to consider the sum of q to the number of such coinversions, summed over all π which map to π' , or equivalently, summed over all ways to interleave the p 2's into the fixed sequence of j 0's and 1's in section 0 of π' . Taking into account the fact that such an interleaving must begin with a 2 but is otherwise unrestricted, we get a factor of

$$\begin{bmatrix} p-1+j \\ j \end{bmatrix}_q, \quad (194)$$

since each 2 will form a coinversion with each 0 and each 1 occurring before it. It is now clear how the various terms in (190) arise.

Finally, we consider the case when there is only one peak, so $p = n - d$. Since there are $d - (k - p) = d - k + n - d = n - k$ D steps above peak 1 of π , we have $\text{bounce}(\pi) = n - k$. Taking area into account, by the above analysis we get

$$S_{n,d,k}(q, t) = t^{n-k} q^{\binom{n-d}{2}} \begin{bmatrix} k \\ n-d \end{bmatrix}_q \begin{bmatrix} n-d-1+n-k \\ n-k \end{bmatrix}_q \quad (195)$$

which agrees with the $p = n - d$ term on the right-hand-side of (190) since $S_{n-k,n-k,j}(q, t) = \delta_{j,n-k}$ from the initial conditions. \square

The following explicit formula for $S_{n,d}(q, t)$ was obtained in [EHKK03].

Theorem 29 For all $0 \leq d < n$,

$$S_{n,d}(q, t) = \sum_{b=1}^{n-d} \sum_{\substack{\alpha_1+\dots+\alpha_b=n-d, \alpha_i>0 \\ \beta_0+\beta_1+\dots+\beta_b=d, \beta_i\geq 0}} \begin{bmatrix} \beta_0 + \alpha_1 \\ \beta_0 \end{bmatrix}_q \begin{bmatrix} \beta_b + \alpha_b - 1 \\ \beta_b \end{bmatrix}_q q^{\binom{\alpha_1}{2}+\dots+\binom{\alpha_b}{2}} \quad (196)$$

$$t^{\beta_1+2\beta_2+\dots+b\beta_b+\alpha_2+2\alpha_3+\dots+(b-1)\alpha_b} \prod_{i=1}^{b-1} \begin{bmatrix} \beta_i + \alpha_{i+1} + \alpha_i - 1 \\ \beta_i, \alpha_{i+1}, \alpha_i - 1 \end{bmatrix}_q.$$

Proof. Consider the sum of $q^{\text{area}} t^{\text{bounce}}$ over all π which have bounce vector $(\alpha_1, \dots, \alpha_b)$, and shift vector $(\beta_0, \beta_1, \dots, \beta_b)$. For all such π the value of bounce is given by the exponent of t in (196). The area below the bounce path generates the $q^{\binom{\alpha_1}{2}+\dots+\binom{\alpha_b}{2}}$ term. When computing the portion of area above the bounce path, section 0 of π contributes the $\begin{bmatrix} \beta_0+\alpha_1 \\ \beta_0 \end{bmatrix}_q$ term. Similarly, section b contributes the $\begin{bmatrix} \beta_b+\alpha_b-1 \\ \beta_b \end{bmatrix}_q$ term (the first step above peak b must be an E step by the definition of a peak, which explains why we subtract 1 from α_b). For section i , $1 \leq i < b$, we sum over all ways to interleave the β_i D steps with the α_{i+1} N steps and the α_i E steps, subject to the constraint we start with an E step. By the boundary lemma, we get the $\begin{bmatrix} \beta_i+\alpha_{i+1}+\alpha_i-1 \\ \beta_i, \alpha_{i+1}, \alpha_i-1 \end{bmatrix}_q$ term. \square

The Special Value $t = 1/q$

Theorem 30 For $1 \leq k \leq n$ and $0 \leq d \leq n$,

$$q^{\binom{n}{2}-\binom{d}{2}} S_{n,d,k}(q, 1/q) = q^{(k-1)(n-d)} \frac{[k]}{[n]} \begin{bmatrix} 2n-k-d-1 \\ n-k \end{bmatrix}_q \begin{bmatrix} n \\ d \end{bmatrix}_q. \quad (197)$$

Proof. (Sketch). The result can be obtained by induction, as in the case of the proof of Theorem 14. The details of this argument can be found in [Hag08][pp. 54-56]. \square

Corollary 12 For $0 \leq d \leq n$,

$$q^{\binom{n}{2}-\binom{d}{2}} S_{n,d}(q, 1/q) = \frac{1}{[n-d+1]} \begin{bmatrix} 2n-d \\ n-d, n-d, d \end{bmatrix}_q. \quad (198)$$

Proof. It is easy to see combinatorially that $S_{n+1,d,1}(q, t) = t^n S_{n,d}(q, t)$. Thus

$$q^{\binom{n}{2}-\binom{d}{2}} S_{n,d}(q, 1/q) = q^{\binom{n}{2}+n-\binom{d}{2}} S_{n+1,d,1}(q, 1/q) \quad (199)$$

$$= q^{\binom{n+1}{2}-\binom{d}{2}} S_{n+1,d,1}(q, 1/q) \quad (200)$$

$$= q^{(1-1)(n+1-d)} \frac{[1]}{[n+1]} \left[\begin{matrix} 2(n+1) - 1 - d - 1 \\ n \end{matrix} \right]_q \left[\begin{matrix} n+1 \\ d \end{matrix} \right]_q \quad (201)$$

$$= \frac{1}{[n-d+1]} \left[\begin{matrix} 2n-d \\ n-d, n-d, d \end{matrix} \right]_q. \quad (202)$$

□

Remark 10 *Corollary 12 proves that $S_{n,d}(q, t)$ is symmetric in q, t when $t = 1/q$. For we have*

$$S_{n,d}(q, 1/q) = q^{-\binom{n}{2}+\binom{d}{2}} \frac{1}{[n-d+1]} \left[\begin{matrix} 2n-d \\ n-d, n-d, d \end{matrix} \right]_q, \quad (203)$$

and replacing q by $1/q$ we get

$$S_{n,d}(1/q, q) = q^{\binom{n}{2}-\binom{d}{2}} \frac{q^{n-d}}{[n-d+1]} \left[\begin{matrix} 2n-d \\ n-d, n-d, d \end{matrix} \right]_q q^{2\binom{n-d}{2}+\binom{d}{2}-\binom{2n-d}{2}}, \quad (204)$$

since $[n]!_{1/q} = [n]! q^{-\binom{n}{2}}$. Now

$$\binom{n}{2} - \binom{d}{2} + n - d + 2 \binom{n-d}{2} + \binom{d}{2} - \binom{2n-d}{2} = \binom{d}{2} - \binom{n}{2}, \quad (205)$$

so $S_{n,d}(q, 1/q) = S_{n,d}(1/q, q)$. It is of course an open problem to show $S_{n,d}(q, t) = S_{n,d}(t, q)$ bijectively, since the $d = 0$ case is Open Problem 1.

A Schröder div-Statistic

Let

$$C_n(q, t, w) = \sum_{d=0}^n w^d S_{n,d}(q, t), \quad (206)$$

and for $\pi \in L_{n,n}^+$, let $a'_i(\pi)$ equal the number of area squares in the i th column from the right. Also set $a'_0(\pi) = -1$ for all π . For example, for the path on the right in Figure 9, we have $(a'_0, a'_1, a'_2, \dots, a'_8) = (-1, 0, 1, 1, 2, 3, 3, 1, 0)$. The (q, t) -Schröder can be expressed strictly in terms of Dyck paths as follows.

Theorem 31

$$C_n(q, t, w) = \sum_{\pi \in L_{n,n}^+} q^{\text{area}(\pi)} t^{\text{bounce}(\pi)} \prod_{\substack{1 \leq i \leq n \\ a'_i > a'_{i-1}}} (1 + w/q^{a'_i}). \quad (207)$$

Proof. (sketch) Show the coefficient of w^d in (207) satisfies the same recurrence as (190). \square

Next define the *reading order* of the rows of π to be the order in which the rows are listed by decreasing value of a_i , where if two rows have the same a_i -value, the row above is listed first. For the path on the left in Figure 9, the reading order is

$$\text{row 6, row 8, row 5, row 4, row 3, row 7, row 2, row 1.} \quad (208)$$

Finally let $b_k = b_k(\pi)$ be the number of inversion pairs as in Definition 4 which involve the k th row in the reading order and rows before it in the reading order, and set $b_0 = -1$. For the path on the left in Figure 9, we have

$$(b_0, b_1, \dots, b_8) = (-1, 0, 1, 1, 2, 3, 3, 1, 0). \quad (209)$$

Note that in this example $a'_i(\zeta(\pi)) = b_i(\pi)$ for all i , and it is not hard to see that this is true in general. Hence we have

$$C_n(q, t, w) = \sum_{\pi \in L_{n,n}^+} q^{\text{dinv}(\pi)} t^{\text{area}(\pi)} \prod_{\substack{1 \leq i \leq n \\ b_i > b_{i-1}}} (1 + w/q^{b_i}). \quad (210)$$

It is also easy to see that $b_i > b_{i-1}$ if and only if row i contains a column top, i.e. the N step of the path in that row is followed immediately by an E step.

Now to get a term in (210) contributing to $S_{n,d}(q, t)$ we make a selection of d column tops, and for the rows containing those column tops we subtract the corresponding b_i contribution to dinv . If we start with the path π and replace those column tops by D steps, we get a Schröder path, and we can define dinv of this path as $\text{dinv}(\pi)$ minus the sum of the chosen b_i .

The Shuffle Conjecture

In [HHL⁺05b] a nice conjecture for the expansion of $\mathcal{F}(DH_n; q, t)$ into monomials is introduced. It is often referred to as the shuffle conjecture, since it can be phrased in the following simple way: decompose $\{1, 2, \dots, n\}$ into increasing sequences of consecutive integers $\alpha_1, \alpha_2, \dots, \alpha_k$ of lengths $|\alpha_1|, |\alpha_2|, \dots$ and decreasing sequences of consecutive integers β_1, \dots, β_s of lengths $|\beta_1|, |\beta_2|, \dots$. For example, if $n = 8$ we might have

$$k = 1, s = 2, \alpha_1 = \{6, 7, 8\}, \beta_1 = \{5, 4, 3\}, \beta_2 = \{2, 1\}. \quad (211)$$

Given such a decomposition, we say a permutation $\sigma \in S_n$ is an α, β -shuffle if for each i, j all the terms in α_i occur in increasing order in σ , and all the terms of β_j occur in decreasing order in σ . For example, for α, β as in (211), the permutation 26571483 is an α, β -shuffle.

Conjecture 2 (*The Shuffle Conjecture: [HHL⁺05b]*)

$$\langle \mathcal{F}(DH_n; q, t), h_{|\alpha_1|} h_{|\alpha_2|} \cdots h_{|\alpha_k|} e_{|\beta_1|} e_{|\beta_2|} \cdots e_{|\beta_s|} \rangle = \sum_{\substack{P \in \mathcal{P}_n \\ \text{read}(P) \text{ is an } \alpha, \beta\text{-shuffle}}} q^{\text{dinv}(P)} t^{\text{area}(P)}. \quad (212)$$

If our decomposition of $\{1, 2, \dots, n\}$ is into n sequences consisting of only one element each, then the set of α, β -shuffles is the set of all parking functions. By Remark 4 the left-hand-side of (212) gives $\mathcal{H}(DH_n; q, t)$, and so in this case the shuffle conjecture reduces to Conjecture 1.

On the other hand, consider the case $k = s = 1$, $\alpha_1 = n - d + 1, \dots, n$, $\beta_1 = n - d, \dots, 1$. The left-hand-side of (212) reduces to $\langle \mathcal{F}(DH_n; q, t), h_d e_{n-d} \rangle$, the q, t -Schröder. If $\text{read}(P)$ is an α, β -shuffle, we must have all the elements of α_1 occurring at the top of columns. It is easy to see that none of these cars can form divn -pairs with any other car which occurs before them in the reading order. We can identify columns containing elements of α_1 at the top with selections in the right-hand-side of (210) of the d -column tops to be regarded as D steps, and one finds in fact that the Schröder divn -statistic in the right-hand-side of (210) is the same as $\text{divn}(P)$.

For a subset D of $\{1, 2, \dots, n - 1\}$, let

$$\mathcal{Q}_{n,D}(Z) = \sum_{\substack{a_1 \leq a_2 \leq \dots \leq a_n \\ a_i = a_{i+1} \implies i \notin D}} z_{a_1} z_{a_2} \cdots z_{a_n} \quad (213)$$

denote Gessel's fundamental quasisymmetric function. Another equivalent form of the Shuffle Conjecture appearing in [HHL⁺05b] is the statement that

$$\mathcal{F}(DH_n; q, t) = \sum_{P \in \mathcal{P}_n} q^{\text{divn}(P)} t^{\text{area}(P)} \mathcal{Q}_{n, \text{Ides}(\text{read}(P))}(x_1, \dots, x_n), \quad (214)$$

where recall that for any permutation $\sigma \in S_n$, $\text{Ides}(\sigma)$ is the set of all i for which $i + 1$ occurs before i in σ . The authors show that the sum

$$A_\pi(x_1, \dots, x_n; q) = \sum_{\substack{P \in \mathcal{P}_n \\ \pi \text{ fixed}}} q^{\text{divn}(P)} \mathcal{Q}_{n, \text{Ides}(\text{read}(P))}(x_1, \dots, x_n), \quad (215)$$

obtained by restricting the right-hand-side of (214) to a fixed path π , is a special case of a family of symmetric functions introduced by Lascoux, Leclerc, and Thibon [LLT97] commonly called LLT polynomials. In [LLT97] it is conjectured that these polynomials are always Schur positive, and two recent preprints claim to give independent proofs of this conjecture. One of these is by Grojnowski and Haiman [GH06], and uses the representation theory of Hecke algebras. The other, by S. Assaf [Ass13], is a purely combinatorial construction involving objects called dual equivalence graphs.

In [Hag08][Theorem 6.8, p. 98] it is shown that if π is a path with the property that each non-empty column has its base on the diagonal $x = y$ (a so called “balanced” path), then the Schur coefficients of $A_\pi(x_1, \dots, x_n; q)$ can be expressed in terms of the charge statistic of Algorithm 1. Hence one could hope that for general LLT polynomials, or at least for the type of LLT's corresponding to Dyck paths, there is some similar formula. Note that the product $e_{\beta(\pi)}$ in (139) can be easily expanded in terms of Schur functions, and in fact the coefficient of s_λ in e_β is $K_{\lambda, \beta}$. Thus there may be a way of associating powers of q with SSYT, depending on the shape of π in some way, to generate the LLT polynomial $A_\pi(x_1, \dots, x_n; q)$.

Open Problem 4 *Find a nice formula, perhaps in terms of a generalized charge statistic, for the coefficients in the Schur expansion of the LLT polynomial corresponding to a given Dyck path, i.e., the right-hand-side of (215).*

Assaf's construction in terms of dual equivalence graphs does yield a combinatorial formula of sorts for an arbitrary LLT polynomial, but her construction is rather involved, and it is not yet known how to reproduce explicit formulas, like the one for balanced paths in terms of charge, from her formula. Note that the shuffle conjecture gives a prediction for the coefficient of a monomial symmetric function in $\mathcal{F}(DH_n; q, t)$, but does not (except in the hook case) give a nice conjecture for the more desirable Schur coefficients.

5 Rational Catalan Combinatorics

The Superpolynomial Invariant of a Torus Knot

Throughout this section (m, n) is a fixed pair of relatively prime, positive integers. In the last few years an exciting generalization of the q, t -Schröder and the shuffle conjecture has been introduced. This generalization depends on an arbitrary pair (m, n) , and has an interpretation in terms of knot theory. By a knot we mean an embedding of a circle in \mathbb{R}^3 , and by a knot invariant a polynomial which is the same on equivalent knots. Two classical knot invariants on a knot K are the Jones polynomial $V_K(t)$ and the HOMFLY polynomial $P_K(a, q)$. Dunfield, Gukov, and Rasmussen [DGR06] hypothesized the existence of a *superpolynomial* knot invariant $P_K(a, q, t)$ which would contain the HOMFLY and Jones polynomials as limiting cases, as well as having other desirable properties. Possible definitions of the superpolynomial for torus knots $T_{(m,n)}$ have recently been suggested by Angnanovic and Shakirov [AS11] (see also [AS12]), Cherednik [Che13], and Oblomkov, Rasmussen, and Shende [ORS12]. All three methods seem to give the same polynomial, and in fact Gorsky and Negut [GN13] have proved the descriptions in [AS11] and [Che13] do in fact give the same polynomial. The description in [AS11] is in terms of Macdonald polynomials, and Gorsky first realized that when $m = n + 1$, if we use the Cherednik parametrization, then the superpolynomial can be expressed as the function $C_n(q, t, -a)$ from (210), giving a completely new interpretation for the q, t -Schröder.

In [ORS12] a conjectured combinatorial expression for the superpolynomial of $T(m, n)$ in terms of weighted lattice paths is given, which we now describe. Let $\text{Grid}(m, n)$ be the $n \times m$ grid of labelled squares whose upper-left-hand corner square is labelled with $(n - 1)(m - 1) - 1$, and whose labels decrease by m as you go down columns and by n as you go across rows. For example,

$$\text{Grid}(3, 7) = \begin{array}{|c|c|c|} \hline 11 & 4 & -3 \\ \hline 8 & 1 & -6 \\ \hline 5 & -2 & -9 \\ \hline 2 & -5 & -12 \\ \hline -1 & -8 & -15 \\ \hline -4 & -11 & -18 \\ \hline -7 & -14 & -21 \\ \hline \end{array} \quad (216)$$

To the corners of the squares of $\text{Grid}(m, n)$ we associate Cartesian coordinates, where the lower-left-hand corner of the grid has coordinates $(0, 0)$, and the upper-right-hand-corner of the grid (m, n) . Let $L_{(m,n)}^+$ denote the set of lattice paths π for which none of the squares with negative labels are above π . (This agrees with our definition of $L_{(m,n)}^+$ from Section 1 as paths which stay above the line $my = nx$). For a given π , we let $\text{area}(\pi)$ denote the number of squares in $\text{Grid}(m, n)$ with positive labels which are below π . Furthermore, let $\text{dinv}(\pi)$ denote the number of squares in $\text{Grid}(m, n)$ which are above π and whose arm and leg lengths satisfy

$$\frac{a}{l+1} < \frac{m}{n} < \frac{a+1}{l}. \quad (217)$$

For example, if $(m, n) = (3, 7)$ and $\pi = NNNNNEENNE$, then $\text{area}(\pi) = 2$ (corresponding to the squares with labels 2 and 5). Also, $\text{dinv}(\pi) = 2$; the squares with labels 11, 8, 4, 1 have

$a = l = 1, a = 1, l = 0, a = 0, l = 1, a = l = 0$, respectively, and so the squares with labels 8 and 11 do not satisfy (217), while the squares with labels 1 and 4 do.

Next we define a generalization of the formula (210) for general (m, n) . Given $\pi \in L_{(m,n)}^+$, let $R(\pi)$ denote the set of labels of squares which are at the top of some column of π . Say these labels occur in columns c_1, c_2, \dots, c_k as we move left to right. Then for $1 \leq i \leq k$, let t_i denote the label of the square which is in the same row as the square at the top of column c_i , and also in column c_{i+1} , and set $T(\pi) = \{t_1, t_2, \dots, t_{k-1}\}$. For example, if π is the path on the left of Figure 23, then

$$R(\pi) = \{-3, 1, 5\} \quad (218)$$

$$T(\pi) = \{-6, -2\}. \quad (219)$$

Now form a vector $\alpha(\pi) = (\alpha_1, \dots, \alpha_k)$ consisting of the elements of $R(\pi)$ in decreasing order, and let $c_i(\pi)$ denote the number of elements of $R(\pi)$ which are larger than α_i , minus the number of elements of $T(\pi)$ which are larger than α_i . For the example of (218), we have $\alpha = (5, 1, -3)$, and so $c_1 = 0 - 0 = 0, c_2 = 1 - 0 = 1, c_3 = 2 - 1 = 1$. Furthermore set $c_0 = -1$.

Conjecture 3 [ORS12] *For any pair (m, n) of positive, relatively prime integers,*

$$P_{T(m,n)}(-w, q, t) = \sum_{\pi \in L_{m,n}^+} q^{\text{dinv}(\pi)} t^{\text{area}(\pi)} \prod_{\substack{c_i > c_{i-1} \\ 1 \leq i \leq k}} (1 + w/q^{c_i}). \quad (220)$$

Here $T(m, n)$ is the (m, n) torus knot, which winds around the torus m times in one direction and n times in the other before returning to the starting point, and we use the parametrization of the superpolynomial occurring in [Che13][p. 18, eq. (2.12)].

Exercise 11 *Show that if $m = n + 1$, (220) reduces to (210).*

There is also a version of the shuffle conjecture for any (m, n) . Let an (m, n) -parking function be a path $\pi \in L_{(m,n)}^+$ together with a placement of the integers 1 through n (called *cars*) just to the right of the N steps of π , with strict decrease down columns. For such a pair P , we let $\text{rank}(j)$ be the label of the square that contains j , and we set

$$\text{tdinv}(P) = |\{(i, j) : 1 \leq i < j \leq n \text{ and } \text{rank}(i) < \text{rank}(j) < \text{rank}(i) + m\}|. \quad (221)$$

Furthermore we let the reading word $\text{read}(P)$ be the permutation obtained by listing the cars by decreasing order of their ranks. For example, for the $(3, 7)$ -parking function of Figure 22, $\text{tdinv} = 3$, with inversion pairs formed by pairs of cars $(6, 7)$, $(4, 6)$, and $(2, 4)$, and the reading word is 7642531. Let $\text{maxtdinv}(\pi)$ be tdinv of the parking function for π whose reading word is the reverse of the identity, and for any parking function P for π set

$$\text{dinv}(P) = \text{dinv}(\pi) + \text{tdinv}(P) - \text{maxtdinv}(\pi). \quad (222)$$

Then the combinatorial side of the (m, n) shuffle conjecture is the function

$$B_{(m,n)}(x_1, \dots, x_n; q, t) = \sum_{(m,n) \text{ parking functions } P} q^{\text{dinv}(P)} t^{\text{area}(\pi)} \mathcal{Q}_{n, \text{Ides}(\text{read}(P))}(x_1, \dots, x_n). \quad (223)$$

		5
	6	
	2	
7		
4		
3		
1		

Figure 22: A (3, 7)-parking function.

Gorsky and Negut [GN13] show how the results of Aganagic and Shakirov on torus knot invariants can be expressed in terms of Macdonald polynomials using advanced objects such as the Hilbert scheme. Bergeron, Garsia, Leven, and Xin [BGLX14a], [BGLX14b] have shown how this Macdonald polynomial construction can be done combinatorially with plethystic symmetric function operators, and in fact they define operators $Q_{(m,n)}$ for any relatively prime (m, n) by a recursive procedure. The rational shuffle conjecture can then be phrased as $Q_{(m,n)}(-\mathbf{1})^{\mathbf{n}} = B_{(m,n)}(x_1, \dots, x_n; q, t)$. The symmetric function $Q_{(n+1,n)}(-\mathbf{1})^{\mathbf{n}}$ reduces to ∇e_n , and so the rational shuffle conjecture reduces to the original shuffle conjecture when $m = n + 1$.

Gorsky and Negut also conjecture that $Q_{(m,n)}(-\mathbf{1})^{\mathbf{n}}$ is the Frobenius series of the unique finite-dimensional irreducible representation of the rational Cherednik algebra with parameter m/n , with respect to a certain bigrading. Hikita [Hik14] has shown that $B_{(m,n)}(x_1, \dots, x_n; q, t)$ is the bigraded Frobenius series of certain S_n -modules arising in the study of the homology of type A affine Springer fibers, which gives another possible way of attacking the rational shuffle conjecture. We mention that the portion of the right-hand-side of (223) corresponding to a fixed path π is an LLT polynomial, and hence is Schur positive.

Many of the results in this chapter involving the special cases $t = 1$ and $t = 1/q$ have elegant extensions to general, relatively prime (m, n) . For example, Gorsky and Negut [GN13] prove that when $t = 1/q$ the q, t -Catalan for (m, n) , obtained by taking the coefficient of s_1^n in $Q_{(m,n)}(-\mathbf{1})^{\mathbf{n}}$, reduces to

$$\frac{1}{[m]} \begin{bmatrix} m+n-1 \\ n \end{bmatrix}. \tag{224}$$

Another example is that the total number of (m, n) -parking functions is m^{n-1} .

Tesler Matrices and the Superpolynomial

There is a general formula for $Q_{(m,n)}(-\mathbf{1})^{\mathbf{n}}$ in terms of Tesler matrices.

Theorem 32 (Gorsky, Negut 2013) *For any pair of positive, relatively prime integers (m, n) ,*

$$Q_{m,n}(-\mathbf{1})^{\mathbf{n}} = \sum_{C \in \text{Tes}(m,n)} \prod_{i=1}^m e_{c_{ii}} \prod_{\substack{1 \leq i < m \\ c_{i,i+1} > 0}} ([c_{i,i+1} + 1]_{q,t} - [c_{i,i+1}]_{q,t}) \prod_{\substack{2 \leq i+1 < j \leq m \\ c_{i,j} > 0}} (-M)[c_{i,j}]_{q,t}. \tag{225}$$

Here $\text{Tes}(m, n)$ is the set of $m \times m$ upper-triangular matrices C satisfying

$$c_{i,i} + \sum_{j>i} c_{i,j} - \sum_{j<i} c_{j,i} = \left\lfloor \frac{in}{m} \right\rfloor - \left\lfloor \frac{(i-1)n}{m} \right\rfloor, \quad 1 \leq i \leq m. \quad (226)$$

Example 4 Given a symmetric function f expressed as a polynomial in the e_k , the coefficient of s_1^n in f can be found by simply replacing each e_k by 1. Now when $m = n + 1$ the conditions (226) reduce to the hook sums all equal 1 except for the first which equals 0. Having a first hook sum equal to 0 forces the first row to be all zeros, and so $\text{Tes}(n + 1, n)$ is really just the same as $\text{Tes}(n)$. Hence taking the weights from (225) when $n = 3$ for the matrices in (168), setting all $e_{c_{ii}} = 1$, we get

$$C_3(q, t) = 1 + ([2] - [1]) + ([2] - [1]) + ([2] - [1])^2 + \quad (227)$$

$$+ ([3] - [2])([2] - [1]) - M - M([2] - [1]) \\ = 1 + (q + t - 1) + (q + t - 1) + (q + t - 1)^2 \quad (228)$$

$$+ (q^2 + qt + t^2 - q - t)(q + t - 1) \\ - (1 - q)(1 - t) - (1 - q)(1 - t)(q + t - 1) \\ = q^3 + q^2t + qt^2 + t^3. \quad (229)$$

Garsia and Haglund [GH] independently obtained a Tesler matrix expression for ∇e_n , although it is a bit more complicated to state than the $m = n + 1$ case of (225).

The superpolynomial for the (m, n) Torus knot can be defined analytically as

$$\mathcal{P}_{T(m,n)}(a, q, t) = \sum_{d \geq 0} (-a)^{n-d} \langle Q_{(m,n)}(-\mathbf{1}^n, e_d h_{n-d} \rangle. \quad (230)$$

As a corollary of (225), Gorsky and Negut obtain the following.

Corollary 13 For any pair of positive, relatively prime integers (m, n) ,

$$\mathcal{P}_{T(m,n)}(a, q, t) = \sum_{C \in \text{Tes}(m,n)} \prod_{\substack{1 \leq i \leq m \\ c_{i,i} > 0}} (1 - a) \prod_{1 \leq i < m} ([c_{i,i+1} + 1]_{q,t} - [c_{i,i+1}]_{q,t}) \prod_{\substack{2 \leq i+1 < j \leq m \\ c_{i,j} > 0}} (-M)[c_{i,j}]_{q,t}. \quad (231)$$

There are a number of intriguing open problems involving the combinatorics of (m, n) -Catalan paths. For example, there is a candidate extension of the zeta map of Figure 9 which can be described as follows. Given a path $\pi \in L_{(m,n)}^+$, call the set of corners of grid squares which are touched by π the “vertices” of π . Next define $S(\pi)$ to be the set consisting of the labels of those squares whose upper-left-hand-corners are vertices of π . A given label in $S(\pi)$ is called an N label if the vertex associated to it is the start of an N step, otherwise it is called an E label. For example, if π is the path on the left in Figure 23, then

$$\pi = NNNNNENENE \quad S(\pi) = \{-10, -7, -4, -1, 2, 5, -2, 1, -6, -3\}. \quad (232)$$

We now define the “sweep map” of [ALW14], denoted ζ , from $L_{(m,n)}^+$ to $L_{(m,n)}^+$ as follows: order the elements of $S(\pi)$ in increasing order to create a vector of labels $D(\pi) = (d_1, d_2, \dots, d_{m+n})$.

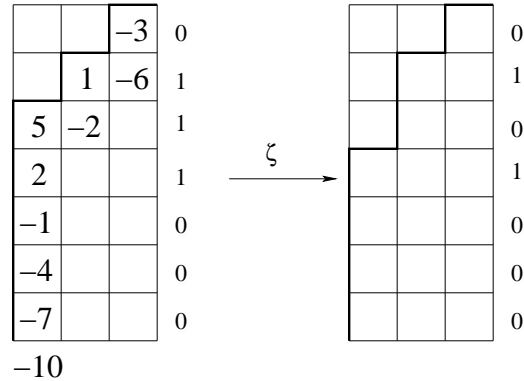

Figure 23: The sweep map.

Then create a path $\phi(\pi)$ by defining the i th step of $\phi(\pi)$ to be an N step if d_i is an N label, and an E step if d_i is an E label. For the example in (232), we have

$$D(\pi) = (-10, -7, -6, -4, -3, -2, -1, 1, 2, 5) \quad \phi(\pi) = NNNNENNE. \quad (233)$$

Exercise 12 Show that when $m = n + 1$, paths in $L^+_{(m,n)}$ are in bijection with paths in $L^+_{(n,n)}$, and that the sweep map reduces to the ζ map of Figure 9.

Open Problem 5 Prove that for general coprime (m, n) the sweep map is a bijection from $L^+_{(m,n)} \rightarrow L^+_{(m,n)}$.

This problem has been studied by Gorsky, Mazin, and Vazirani [GMV14] and Armstrong, Loehr, and Warrington [ALW14]. See also [AHJ14]. In [GMV14] it is shown that the sweep map is a bijection whenever $m = kn + 1$ or $m = kn - 1$ for some positive integer k . We note that in the case $m = kn + 1$ Loehr [Loe03], [Loe05b] (see also [Hag08][pp. 108-109]) has defined an extension of the bounce statistic, which when combined with area generates the q, t -Catalan for $m = kn + 1$. For this “paths in a $n \times kn$ rectangle” case there is also an interpretation for the rational shuffle conjecture in terms of a generalization of diagonal harmonics (see [HHL⁺05b]).

References

- [AAR99] G. E. Andrews, R. Askey, and R. Roy. *Special Functions*, volume 71 of *Encyclopedia of Mathematics and its Applications*. Cambridge University Press, Cambridge, 1999.
- [AHJ14] Drew Armstrong, Christopher R. H. Hanusa, and Brant C. Jones. Results and conjectures on simultaneous core partitions. *European J. Combin.*, 41:205–220, 2014.
- [AKOP02] G. E. Andrews, C. Krattenthaler, L. Orsina, and P. Papi. ad -Nilpotent b -ideals in $\mathfrak{sl}(n)$ having a fixed class of nilpotence: combinatorics and enumeration. *Trans. Amer. Math. Soc.*, 354(10):3835–3853 (electronic), 2002.

- [ALW14] D. Armstrong, N. Loehr, and G. Warrington. Rational parking functions and Catalan numbers. *Math arXiv:1403.1845*, 2014.
- [And75] G. E. Andrews. Identities in combinatorics, II: a q -analog of the Lagrange inversion theorem. *Proc. Amer. Math. Soc.*, 53:240–245, 1975.
- [AR12] Drew Armstrong and Brendon Rhoades. The Shi arrangement and the Ish arrangement. *Trans. Amer. Math. Soc.*, 364(3):1509–1528, 2012.
- [Arm13] Drew Armstrong. Hyperplane arrangements and diagonal harmonics. *J. Comb.*, 4(2):157–190, 2013.
- [Art76] E. Artin. *Galois Theory*. Notre Dame Mathematical Lectures. Notre Dame Ind., 1976. Reprint of the 1942 original.
- [AS11] M. Aganagic and S. Shakirov. Knot homology from refined Chern-Simons theory. *arXiv:1105.5117*, 2011.
- [AS12] Mina Aganagic and Shamil Shakirov. Refined Chern-Simons theory and knot homology. In *String-Math 2011*, volume 85 of *Proc. Sympos. Pure Math.*, pages 3–31. Amer. Math. Soc., Providence, RI, 2012.
- [Ass13] S. Assaf. Dual equivalence graphs and a combinatorial proof of LLT and Macdonald positivity. *arXiv:1005.3759 dated Oct. 23, 2013*, 2013.
- [BGLX14a] F. Bergeron, A. M. Garsia, E. Leven, and G. Xin. Compositional (km, kn) -shuffle conjectures. *math arXiv:1404.4616*, 2014.
- [BGLX14b] F. Bergeron, A. M. Garsia, E. Leven, and G. Xin. Some remarkable new plethystic operators in the theory of Macdonald polynomials. *math arXiv:1405.0316*, 2014.
- [But94] L. M. Butler. Subgroup lattices and symmetric functions. *Mem. Amer. Math. Soc.*, 112(539):vi+160, 1994.
- [Che13] Ivan Cherednik. Jones polynomials of torus knots via DAHA. *Int. Math. Res. Not. IMRN*, (23):5366–5425, 2013.
- [CR64] L. Carlitz and J. Riordan. Two element lattice permutation numbers and their q -generalization. *Duke J. Math.*, 31:371–388, 1964.
- [DGR06] Nathan M. Dunfield, Sergei Gukov, and Jacob Rasmussen. The superpolynomial for knot homologies. *Experiment. Math.*, 15(2):129–159, 2006.
- [EHKK03] E. Egge, J. Haglund, K. Killpatrick, and D. Kremer. A Schröder generalization of Haglund’s statistic on Catalan paths. *Electron. J. Combin.*, 10:Research Paper 16, 21 pp. (electronic), 2003.
- [FH85] J. Förlinger and J. Hofbauer. q -Catalan numbers. *J. Combin. Theory Ser. A*, 40:248–264, 1985.
- [Foa68] D. Foata. On the Netto inversion number of a sequence. *Proc. Amer. Math. Soc.*, 19:236–240, 1968.

- [Fou74] H. O. Foulkes. A survey of some combinatorial aspects of symmetric functions. In *Permutations (Actes Colloq., Univ. René-Descartes, Paris, 1972)*, pages 79–92. Gauthier-Villars, Paris, 1974.
- [FS78] D. Foata and M.-P. Schützenberger. Major index and inversion number of permutations. *Math. Nachr.*, 83:143–159, 1978.
- [Gar81] A. M. Garsia. A q -analogue of the Lagrange inversion formula. *Houston J. Math.*, 7:205–237, 1981.
- [Ges80] I. Gessel. A noncommutative generalization and q -analog of the Lagrange inversion formula. *Trans. Amer. Math. Soc.*, 257:455–482, 1980.
- [GH] A. M. Garsia and J. Haglund. A polynomial expression for the character of diagonal harmonics. *Annals of Combinatorics*. to appear.
- [GH96] A. M. Garsia and M. Haiman. A remarkable q, t -Catalan sequence and q -Lagrange inversion. *J. Algebraic Combin.*, 5(3):191–244, 1996.
- [GH01] A. M. Garsia and J. Haglund. A positivity result in the theory of Macdonald polynomials. *Proc. Nat. Acad. Sci. U.S.A.*, 98:4313–4316, 2001.
- [GH02] A. M. Garsia and J. Haglund. A proof of the q, t -Catalan positivity conjecture. *Discrete Math.*, 256:677–717, 2002.
- [GH06] I. Grojnowski and M. Haiman. Affine Hecke algebras and positivity of LLT and Macdonald polynomials. 2006. Preprint at <http://www.math.berkeley.edu/~mhaiman/>.
- [GMV14] E. Gorsky, M. Mazin, and M. Vazirani. Affine permutations and rational slope parking functions. *math arXiv:1403.0303*, 2014.
- [GN13] E. Gorsky and A. Negut. Refined knot invariants and Hilbert schemes. *Preprint on the math arXiv: <http://arxiv.org/pdf/1304.3328.pdf>*, 2013.
- [GR04] G. Gasper and M. Rahman. *Basic hypergeometric series, second ed.*, volume 96 of *Encyclopedia of Mathematics and its Applications*. Cambridge University Press, Cambridge, 2004. With a foreword by Richard Askey.
- [Hag03] J. Haglund. Conjectured statistics for the q, t -Catalan numbers. *Adv. Math.*, 175(2):319–334, 2003.
- [Hag04] J. Haglund. A proof of the q, t -Schröder conjecture. *Int. Math. Res. Not.*, 11:525–560, 2004.
- [Hag08] James Haglund. *The q, t -Catalan numbers and the space of diagonal harmonics*, volume 41 of *University Lecture Series*. American Mathematical Society, Providence, RI, 2008. With an appendix on the combinatorics of Macdonald polynomials.
- [Hag11] J. Haglund. A polynomial expression for the Hilbert series of the quotient ring of diagonal coinvariants. *Adv. Math.*, 227:2092–2106, 2011.

- [Hai94] M. Haiman. Conjectures on the quotient ring by diagonal invariants. *J. Algebraic Combin.*, 3:17–76, 1994.
- [Hai00] M. Haiman. Private communication, 2000.
- [Hai02] M. Haiman. Vanishing theorems and character formulas for the Hilbert scheme of points in the plane. *Invent. Math.*, 149:371–407, 2002.
- [HHL05a] J. Haglund, M. Haiman, and N. Loehr. A combinatorial formula for Macdonald polynomials. *Jour. Amer. Math. Soc.*, 18:735–761, 2005.
- [HHL⁺05b] J. Haglund, M. Haiman, N. Loehr, J. B. Remmel, and A. Ulyanov. A combinatorial formula for the character of the diagonal coinvariants. *Duke Math. J.*, 126:195–232, 2005.
- [Hik14] Tatsuyuki Hikita. Affine Springer fibers of type A and combinatorics of diagonal coinvariants. *Adv. Math.*, 263:88–122, 2014.
- [HL05] J. Haglund and N. Loehr. A conjectured combinatorial formula for the Hilbert series for Diagonal Harmonics. *Discrete Math. (Proceedings of the FPSAC 2002 Conference held in Melbourne, Australia)*, 298:189–204, 2005.
- [JL01] G. James and M. Liebeck. *Representations and characters of groups*. Cambridge University Press, New York, second edition, 2001.
- [Lev11] P. Levande. Special cases of the parking functions conjecture and upper-triangular matrices. *DMTCS, Proceedings of the 23rd Internat. Conf. on Formal Power Series and Algebraic Combinatorics (FPSAC 2011)*, pages 635–644, 2011. See www.dmtcs.org/dmtcs-ojs/index.php/proceedings/issue/view/119.
- [Lev12] Paul Levande. *Combinatorial structures and generating functions of Fishburn numbers, parking functions, and Tesler matrices*. ProQuest LLC, Ann Arbor, MI, 2012. Thesis (Ph.D.)—University of Pennsylvania.
- [LLT97] Alain Lascoux, Bernard Leclerc, and Jean-Yves Thibon. Ribbon tableaux, Hall-Littlewood functions, quantum affine algebras, and unipotent varieties. *J. Math. Phys.*, 38(2):1041–1068, 1997.
- [Loe03] N. Loehr. *Multivariate Analogues of Catalan Numbers, Parking Functions, and their Extensions*. Ph.D. Thesis, University of California at San Diego, 2003.
- [Loe05a] Nicholas A. Loehr. Combinatorics of q, t -parking functions. *Adv. in Appl. Math.*, 34(2):408–425, 2005.
- [Loe05b] Nicholas A. Loehr. Conjectured statistics for the higher q, t -Catalan sequences. *Electron. J. Combin.*, 12:Research Paper 9, 54 pp. (electronic), 2005.
- [LR04] Nicholas A. Loehr and Jeffrey B. Remmel. Conjectured combinatorial models for the Hilbert series of generalized diagonal harmonics modules. *Electron. J. Combin.*, 11(1):Research Paper 68, 64 pp. (electronic), 2004.

- [LS78] A. Lascoux and M.-P. Schützenberger. Sur une conjecture de H. O. Foulkes. *C. R. Acad. Sci. Paris Sér. A-B*, 286:A323–A324, 1978.
- [Mac60] P. A. MacMahon. *Combinatory Analysis*. Two volumes (bound as one). Chelsea Publishing Co., New York, 1960.
- [Mac95] I. G. Macdonald. *Symmetric Functions and Hall Polynomials*. Oxford Mathematical Monographs, second ed., Oxford Science Publications. The Clarendon Press Oxford University Press, New York, 1995.
- [ORS12] Alexei Oblomkov, Jacob Rasmussen, and Vivek Shende. The Hilbert scheme of a plane curve singularity and the HOMFLY homology of its link. *math arXiv:1201.2115*, 2012.
- [Sag01] Bruce E. Sagan. *The symmetric group*, volume 203 of *Graduate Texts in Mathematics*. Springer-Verlag, New York, second edition, 2001. Representations, combinatorial algorithms, and symmetric functions.
- [Sta79] R. P. Stanley. Invariants of finite groups and their applications to combinatorics. *Bull. Amer. Math. Soc. (new series)*, 1:475–511, 1979.
- [Sta88] D. Stanton. Recent results for the q -Lagrange inversion formula. In *Ramanujan revisited (Urbana-Champaign, Ill., 1987)*, pages 525–536. Academic Press, Boston, MA, 1988.
- [Sta99] R. P. Stanley. *Enumerative Combinatorics*, volume 2. Cambridge University Press, Cambridge, United Kingdom, 1999.
- [Sta03] R. P. Stanley. Recent progress in algebraic combinatorics. *Bull. Amer. Math. Soc.*, 40:55–68, 2003.
- [Sta12] Richard P. Stanley. *Enumerative combinatorics. Volume 1*, volume 49 of *Cambridge Studies in Advanced Mathematics*. Cambridge University Press, Cambridge, second edition, 2012.